

Installation, Operation and Maintenance Manual

Please read and save these instructions. Read carefully before attempting to assemble, install, operate or maintain the product described. Protect yourself and others by observing all safety information. Failure to comply with instructions could result in personal injury and/or property damage! Retain instructions for future reference.

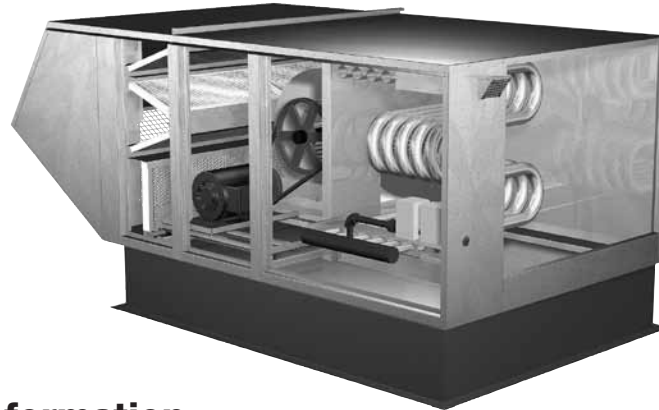

General Safety Information

Only qualified personnel should install this unit. Personnel should have a clear understanding of these instructions and should be aware of general safety precautions. Improper installation can result in electric shock, possible injury due to coming in contact with moving parts, as well as other potential hazards. Other considerations may be required if high winds or seismic activity are present. If more information is needed, contact a licensed professional engineer before moving forward.

1. Follow all local electrical and safety codes, as well as the National Electrical Code (NEC), the National Fire Protection Agency (NFPA), where applicable. Follow the Canadian Electrical Code (CEC) in Canada.
2. The rotation of the wheel is critical. It must be free to rotate without striking or rubbing any stationary objects.
3. Motor must be securely and adequately grounded.
4. Do not spin fan wheel faster than the maximum cataloged fan rpm. Adjustments to fan speed significantly affects motor load. If the fan RPM is changed, the motor current should be checked to make sure it is not exceeding the motor nameplate amps.
5. Do not allow the power cable to kink or come in contact with oil, grease, hot surfaces, or chemicals. Replace cord immediately if damaged.
6. Verify that the power source is compatible with the equipment.
7. Never open blower access doors while the fan is running.

DANGER

Always disconnect power before working on or near a unit. Lock and tag the disconnect switch or breaker to prevent accidental power up.

CAUTION

When servicing the unit, motor may be hot enough to cause pain or injury. Allow motor to cool before servicing.

FOR YOUR SAFETY

If you smell gas:

1. Open windows.
2. Do not touch electrical switches.
3. Extinguish any open flame.
4. Immediately call your gas supplier.

FOR YOUR SAFETY

The use and storage of gasoline or other flammable vapors and liquids in open containers in the vicinity of this appliance is hazardous.

WARNING

Improper installation, adjustment, alteration, service or maintenance can cause property damage, injury or death. Read the installation, operating and maintenance instructions thoroughly before installing or servicing this equipment.

Receiving

Upon receiving the product, check to make sure all items are accounted for by referencing the bill of lading to ensure all items were received. Inspect each crate for shipping damage before accepting delivery. Notify the carrier if any damage is noticed. The carrier will make notification on the delivery receipt acknowledging any damage to the product. All damage should be noted on all the copies of the bill of lading which is countersigned by the delivering carrier. A Carrier Inspection Report should be filled out by the carrier upon arrival and reported to the Traffic Department. If damaged upon arrival, file claim with carrier. Any physical damage to the unit after acceptance is not the responsibility of the manufacturer.

Verify that all required parts and the correct quantity of each item have been received. If any items are missing, report shortages to your local representative to arrange for obtaining missing parts. Sometimes it is not possible that all items for the unit be shipped together due to availability of transportation and truck space. Confirmation of shipment(s) must be limited to only items on the bill of lading.

Handling

Units are to be rigged and moved by the lifting brackets provided or by the skid when a forklift is used. Location of brackets varies by model and size. Handle in such a manner as to keep from scratching or chipping the coating. Damaged finish may reduce ability of unit to resist corrosion.

Storage

Units are protected against damage during shipment. If the unit cannot be installed and operated immediately, precautions need to be taken to prevent deterioration of the unit during storage. The user assumes responsibility of the unit and accessories while in storage. The manufacturer will not be responsible for damage during storage. These suggestions are provided solely as a convenience to the user.

1. Plug all piping.
2. Store belts flat to keep them from warping and stretching.

INDOOR — The ideal environment for the storage of units and accessories is indoors, above grade, in a low humidity atmosphere which is sealed to prevent the entry of blowing dust, rain, or snow. Temperatures should be evenly maintained between 30°F (-1°C) and 110°F (43°C) (wide temperature swings may cause condensation and “sweating” of metal parts). All accessories must be stored indoors in a clean, dry atmosphere.

Remove any accumulations of dirt, water, ice, or snow and wipe dry before moving to indoor storage. To avoid “sweating” of metal parts allow cold parts to reach room temperature. To dry parts and packages use a portable electric heater to get rid of any

moisture build up. Leave coverings loose to permit air circulation and to allow for periodic inspection.

The unit should be stored at least 3½ in. (89 mm) off the floor on wooden blocks covered with moisture proof paper or polyethylene sheathing. Aisles between parts and along all walls should be provided to permit air circulation and space for inspection.

OUTDOOR — Units designed for outdoor applications may be stored outdoors, if absolutely necessary. Roads or aisles for portable cranes and hauling equipment are needed.

The fan should be placed on a level surface to prevent water from leaking into the unit. The unit should be elevated on an adequate number of wooden blocks so that it is above water and snow levels and has enough blocking to prevent it from settling into soft ground. Locate parts far enough apart to permit air circulation, sunlight, and space for periodic inspection. To minimize water accumulation, place all unit parts on blocking supports so that rain water will run off.

Do not cover parts with plastic film or tarps as these cause condensation of moisture from the air passing through heating and cooling cycles.

Inspection and Maintenance during Storage

While in storage, inspect fans once per month. Keep a record of inspection and maintenance performed.

If moisture or dirt accumulations are found on parts, the source should be located and eliminated. At each inspection, rotate the fan wheel by hand ten to fifteen revolutions to distribute lubricant on motor. Every three months, the fan motor should be energized. If paint deterioration begins, consideration should be given to touch-up or repainting. Fans with special coatings may require special techniques for touch-up or repair.

Machined parts coated with rust preventive should be restored to good condition promptly if signs of rust occur. Immediately remove the original rust preventive coating with petroleum solvent and clean with lint-free cloths. Polish any remaining rust from surface with crocus cloth or fine emery paper and oil. Do not destroy the continuity of the surfaces. Wipe thoroughly clean with Tectyl® 506 (Ashland Inc.) or the equivalent. For hard to reach internal surfaces or for occasional use, consider using Tectyl® 511M Rust Preventive or WD-40® or the equivalent.

REMOVING FROM STORAGE — As units are removed from storage to be installed in their final location, they should be protected and maintained in a similar fashion, until the equipment goes into operation.

Prior to installing the unit and system components, inspect the unit assembly to make sure it is in working order.

1. Check all fasteners, set screws on the fan, wheel, bearings, drive, motor base, and accessories for tightness.
2. Rotate the fan wheel(s) by hand and assure no parts are rubbing.

3. After storage period, purge grease before putting fan into service.

Indirect Gas Fired Unit Installations

Units are listed for installation in the United States and Canada.

- Installation of gas fired duct furnaces must conform with local building codes. In the absence of local codes, installation must conform to the National Fuel Gas code, ANSI Z223.1 or in Canada, CAN/CGA-B149 installation codes.
- All electrical wiring must be in accordance with the regulation of the National Electrical Code, ANSI/NFPA 70.
- Unit is approved for installation downstream from refrigeration units. In these conditions, condensate could form in the duct furnace and provision must be made to dispose of the condensate.

Table of Contents

Installation

Clearance to Combustibles/Service Clearances.	3
Indoor Unit.	4
Unit Arrangement DB / HZ.	4-5
Roof Mounted Unit – Arrangement DBC.	5-6
Optional Evaporative Cooling Module.	7
Venting – Outdoor.	7
Indoor, All Units.	8
Standard Indoor.	9
Concentric, General.	10
Concentric, Horizontal.	10-11
Concentric, Vertical.	11-12
Two Pipe, Horizontal.	13
Two Pipe, Vertical.	14
Electrical Wiring.	15-16
Gas Piping.	17
Optional Evaporative Cooler Piping.	18-19
Optional Water Wizard™.	19-20
Optional Direct Expansion (DX) Coil Piping.	20-21
Optional Chilled Water Coil Piping.	22
Optional Building Pressure Control.	22

Start-Up

Blower.	23-24
Furnace – All Units.	25
Single Stage.	25
2:1 Staged.	26
8:1 Staged.	26-28
2:1 Modulation.	29
4:1 Modulation.	30-31
Optional Economizer.	32
Optional Evaporative Cooling.	33
Optional Water Wizard™.	34-35

Operation

Optional Water Wizard™.	35
Optional VAV Units.	36
Optional Recirculating Units.	37

Sequence of Operation, Furnace –	
2:1 Staged.	38
2:1 Modulation.	39-40
Operation of Controller –	
4:1 Modulation/8:1 Staged Controller.	40-41
Sequence of Operation, Furnace –	
4:1 Modulation.	41-42
8:1 Staged.	43-44
Ignition Controller.	44
Economizer.	45

Troubleshooting

Blower.	46
Motor Over Amps.	47
Insufficient / Too Much Airflow.	48
Excessive Noise / Vibration.	49
Furnace – Staged.	50
2:1 Modulation.	51
4:1 Modulation.	52-53
8:1 Staged.	54-55
Optional Evaporative Cooling.	56
Optional Water Wizard™.	57

Maintenance

Routine.	58-59
Fall.	60-61

Reference

Vent Connections.	62
Model IG – Single or 2 Stage.	63
8:1 Staged.	64
2:1 Modulation.	65
4:1 Modulation.	66
Model IGX – Blower Control Center.	67
Single or 2 Stage.	68
8:1 Staged.	68
2:1 Modulation.	69
4:1 Modulation.	69
Performance Table.	70
Start-Up Checklist.	71
Maintenance Log.	Backcover
Warranty.	Backcover

Clearance to Combustibles / Service Clearances

	Floor	Top	Sides	Ends
Indirect Fired Units*	0 inches (0 mm)	0 inches (0 mm)	0 inches (0 mm)	0 inches (0 mm)

Clearance to combustibles is defined as the minimum distance required between the heater and adjacent combustible surfaces to ensure the adjacent surface's temperature does not exceed 90 degrees above the ambient temperature.

*Reference venting guidelines for combustion blower clearances.

Recommended Minimum Service Clearances	
Housing 32 and less	42 inches (1067 mm) on the controls side of the unit

Clearances for component removal (such as evaporative cooler media) should be 6 in. wider than the width of the module itself.

Installation of Indoor Unit

NOTE

To prevent premature heat exchanger failure, do not locate units where chlorinated, halogenated, or acid vapors are present.

1. Install Hangers

Install threaded hangers from ceiling supports. When locating hangers, allow enough room to open access panel(s). Two nuts must be used on the end of each threaded hanger. Ceiling supports are supplied by others.

2. Install Unit

Raise the unit into place. Using two nuts per hanger, fasten the unit supports to hangers under the unit. Appropriate unit supports, such as the optional manufacturer hanging bracket kit or c-channel and angle iron (supplied by others) should be used.

Using self-tapping screws, attach ductwork to unit. In order to prevent the unit from swinging and to provide a safe environment for service and maintenance, additional measures must be taken to secure the unit in all directions.

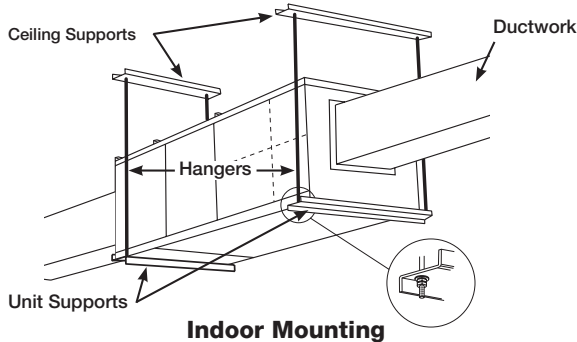

Indoor Mounting

NOTE

Two nuts must be used on each end of each threaded hanging rod for proper support.

WARNING

All factory-provided lifting lugs must be used when lifting any unit. Failure to comply with this safety precaution could result in property damage, serious injury or death.

NOTE

Good duct practices should be followed for all ductwork. Ductwork should be installed in accordance with SMACNA and AMCA guidelines, NFPA 96 and any local codes. Reference the CAPS submittal for duct sizes.

3. Install Vent Piping

Refer to the Indoor Venting Instructions. Refer to your unit submittal to determine the correct venting option.

NOTE

Vent piping is supplied by others and not supplied by manufacturer.

Installation of Arrangement DB / HZ

1. Install Curb and/or Equipment Support(s)

Position curb/equipment support(s) on the roof (reference the CAPS submittal for placement of curb/equipment support(s) in relation to the unit). Verify that unit supports are level, shim if necessary. Attach curb to roof and flash into place. Attach the equipment support(s) to the roof, remove metal cover, flash to wooden nailer and reinstall cover.

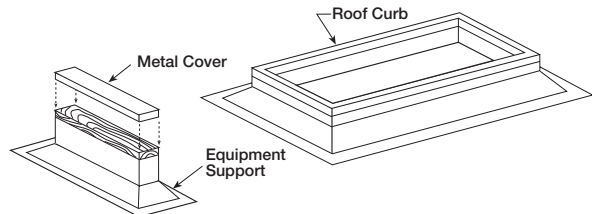

Roof Curb and Equipment Support

2. Install Ductwork

Good duct practices should be followed for all ductwork. All ductwork should be installed in accordance with SMACNA and AMCA guidelines, NFPA 96 and all local codes. Reference the CAPS submittal for ductwork sizes.

Supply Air Ductwork
(Arrangement DB only)

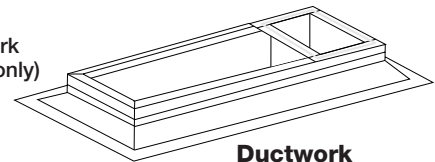

Ductwork

NOTE

The use of a duct adapter is recommended on a downblast (DB) arrangement to align the ductwork with the supply unit. The duct adapter is only a guide and is not to be used as support for the ductwork.

3. Apply Sealant

Apply an appropriate sealant around the perimeter of the curb and duct adapter(s) to isolate fan vibration and prevent water penetration.

4. Install Unit

Use a crane and a set of spreader bars hooked to the factory lifting lugs to lift and center the unit on the curb/equipment support(s).

Use self-tapping sheet metal screws to fasten the unit to the curb/equipment support(s).

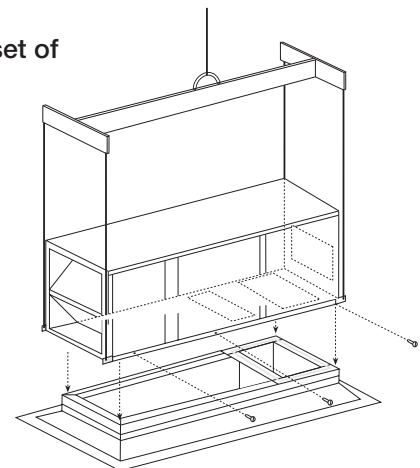

Setting Unit

NOTE

The use of all lifting lugs and a set of spreader bars is mandatory when lifting the unit.

NOTE

Some units come with the weatherhood attached and step 5 may not apply.

5. Assemble and Attach Weatherhood

The weatherhood can now be assembled and attached to the unit. Detailed assembly instructions can be found with the weatherhood. If the optional evaporative cooling module was selected, this step does not apply, refer to the installation instructions for the Optional Evaporative Cooling Module section, page 7.

6. Seal Weatherhood Seam

Using an appropriate sealant, seal the seam between the weatherhood and the unit.

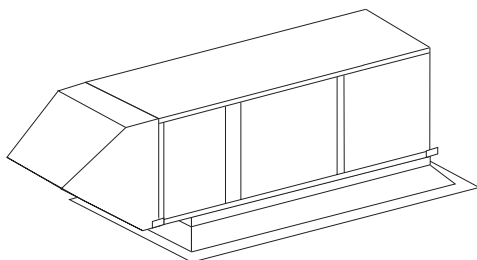

Complete Rooftop Installation

Installation of Roof Mounted Unit Arrangement DBC

1. Install Curb/Equipment Support(s)

Position curb/equipment support(s) on the roof (reference the CAPS submittal for placement of curb/equipment support(s) in relation to the unit). Verify that all unit supports are level, shim if necessary. Attach curb to roof and flash into place. Attach the equipment support(s) to the roof, remove metal cover, flash to wooden nailer and reinstall cover.

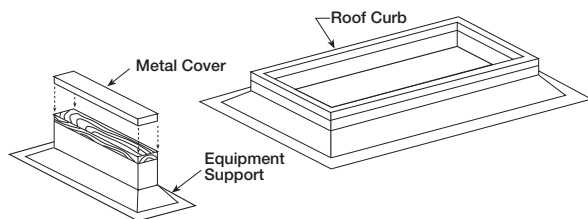

Roof Curb and Equipment Support

NOTE

Refer to Outdoor Venting instructions when locating the unit.

2. Install Combination Curb Adaptor

Install combination curb adaptor over curb, use wood screws to lag in place. Locate extension so the tall louvered side is over the exhaust opening, as shown in illustration. Caulk extension to combination curb adaptor. Fasten extension to curb adaptor with #12 sheet metal screws (field provided).

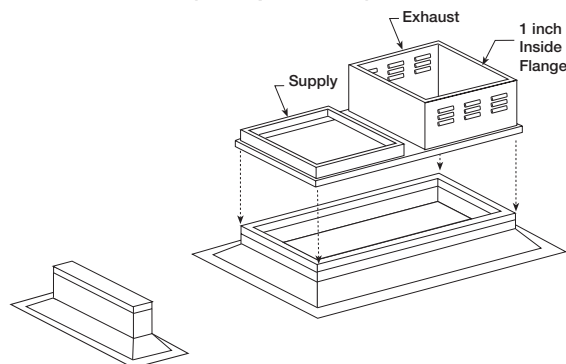

Combination Extension

3. Install Ductwork

Good duct practices should be followed for all ductwork. All ductwork should be installed in accordance with SMACNA and AMCA guidelines, NFPA 96 and any local codes. Reference the CAPS submittal for ductwork size and location.

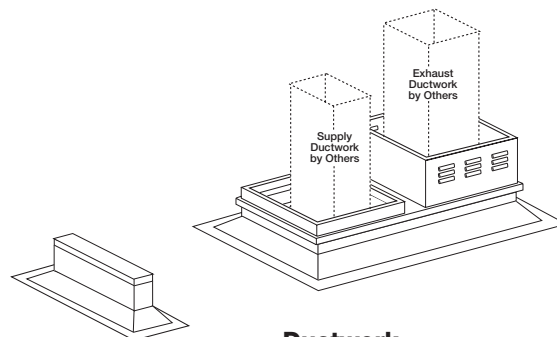

Ductwork

NOTE

The use of a duct adapter is recommended on a downblast (DBC) arrangement to align the ductwork with the supply unit. The duct adapter is only a guide and is not to be used as support for the ductwork.

Installation of Roof Mounted Unit Arrangement DBC, *continued*

4. Apply Sealant

Apply an appropriate sealant around the perimeter of the curb and duct adapter(s) to isolate fan vibration and prevent water penetration.

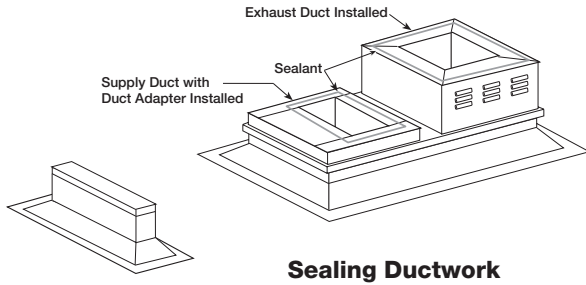

5. Install Exhaust Fan

Fasten exhaust fan to curb extension with self-tapping sheet metal screws.

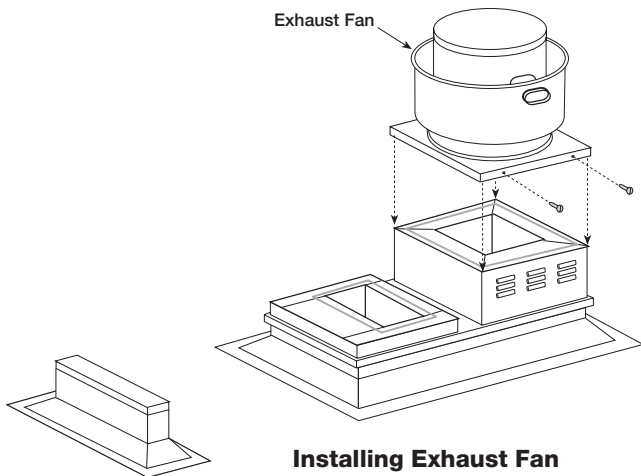

NOTE

Installing the exhaust fan prior to the supply unit will allow for easier installation of options.

6. Install Exhaust Options

Install optional hinge kit with restraining cables and grease trap with drain connection.

NOTE

NFPA 96 requires that the exhaust fan be hinged.

7. Install Supply Unit

Use a crane and a set of spreader bars hooked to the factory lifting lugs to lift and center the unit on the extension/equipment support(s).

Use self-tapping sheet metal screws to fasten the unit to the extension/equipment support(s).

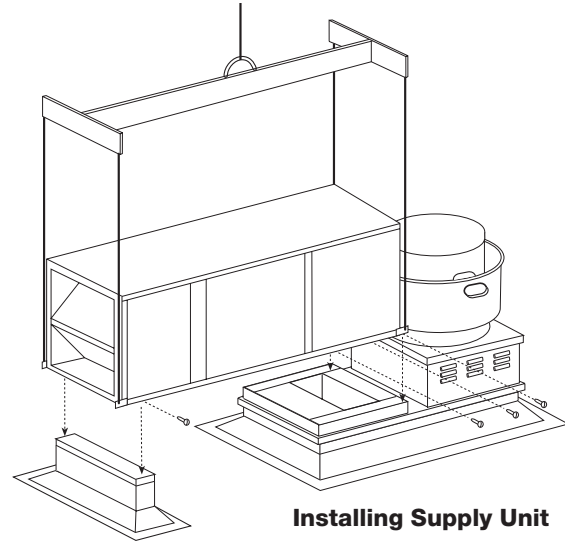

NOTE

The use of all lifting lugs and a set of spreader bars is mandatory when lifting unit.

NOTE

Be sure to complete the outdoor venting installation instructions.

NOTE

Some units come with the weatherhood attached and step 8 may not apply.

8. Assemble and Attach Weatherhood

The weatherhood can now be assembled and/or attached to the unit. Detailed assembly instructions can be found with the weatherhood. If the optional evaporative cooling module was selected, this step does not apply, refer to the Installation Instructions for the Optional Evaporative Cooling Module section, page 7.

9. Seal Weatherhood Seam

Using an appropriate sealant, seal the seam between the weatherhood and the unit.

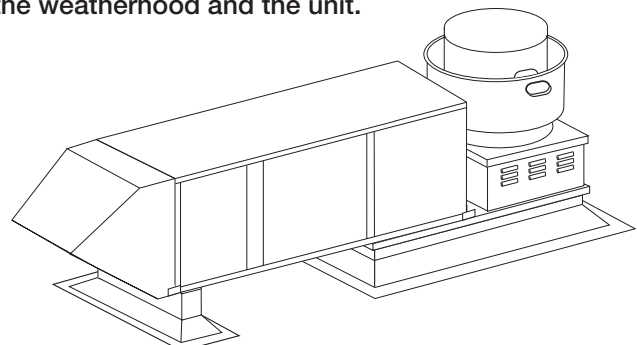

Installation of Evaporative Cooling Module (optional)

NOTE

Small evaporative coolers ship attached to the base unit and require no additional mounting.

1. Locate Equipment Support(s)

Position equipment support(s) on the roof (reference the CAPS submittal for placement of equipment support(s) in relation to the unit). Verify that all unit supports are level, shim if necessary. Attach equipment support to the roof, remove metal cover, flash to wooden nailer and reinstall cover.

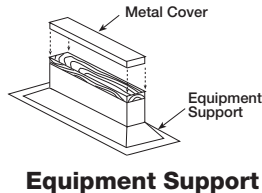

Equipment Support

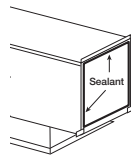

Sealant

2. Apply Sealant

Apply an appropriate sealant around the airstream opening to create an air tight seal.

3. Set Evaporative Cooling Module

Use a crane and a set of spreader bars hooked to the factory lifting lugs to lift and center the module on the equipment support(s). The flange on the evaporative cooler should overlap the flange on the unit.

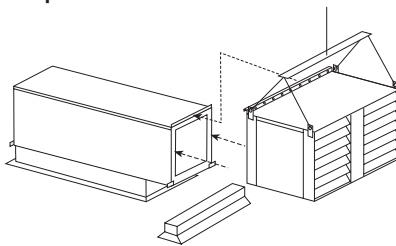

Placing Evaporative Module

NOTE

The use of all lifting lugs and a set of spreader bars is mandatory when lifting the evaporative cooling module.

4. Secure Cooling Module to Unit

Use self-tapping screws to fasten the cooling module to the base unit along the top and down both sides. Fasten at the top through the flanges. To fasten the sides, the media must be removed. To remove the media, first remove the access panel on the evaporative module and disconnect the evaporative pump(s). The media will now slide out. With the media removed, you can access the side fastening points inside the evaporative module. With all the screws in place, reinstall the media, reconnect the pumps and reinstall the access panel.

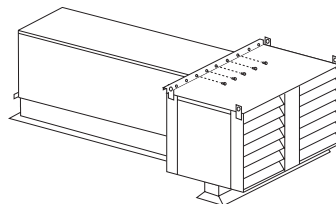

Securing Evaporative Module

NOTE

When mounting the evaporative cooler, it is important that it is level to ensure proper operation and water drainage.

Installation of Venting for Outdoor Units

1. Follow Guidelines

All of the following guidelines must be followed when installing the unit.

WARNING

Do not install units in locations where flue products can be drawn into adjacent building openings such as windows, fresh air intakes, etc. Distance from vent terminal to adjacent public walkways, adjacent buildings, operable windows, and building openings shall conform with the local codes. In the absence of local codes, installation shall conform with the National Fuel Gas Code, ANSI Z223.1, or the CAN/CGA B-149 Installation Codes.

WARNING

The following guidelines must be followed for all outdoor units:

1. Building materials that will be affected by flue gases should be protected.
2. Maintain minimum horizontal clearance of 4 feet from electric meters, gas meters, regulators, and relief equipment. In Canada, the minimum clearance is 6 feet.
3. The combustion blower discharge on outdoor units must be located a minimum of 42 inches from any combustible materials.
4. Do not modify or obstruct the combustion air inlet cover or the combustion blower weatherhood.
5. Do not add vents other than those supplied by the manufacturer.
6. During the winter, keep the unit clear of snow to prevent any blockage of the combustion venting.

2. Install Stack (Optional)

Clearance may require an exhaust stack. Install an exhaust stack as needed to the exhaust connection on the unit. Install a vent terminal on the exhaust pipe.

Installation of Venting for Indoor Units

WARNING

The following guidelines must be followed for all indoor units:

1. Installation of venting must conform with local building codes. In the absence of local codes, installation must conform with the National Fuel Gas Code, ANSI Z223.1 or in Canada, CAN/CGA-B149 installations codes.
2. For the exhaust pipe, use pipe approved for a category III appliance or single wall, 26 gauge or heavier galvanized vent pipe. The piping is required to be gas tight by ANSI.
3. For the combustion air pipe on separated combustion units, sealed single-wall galvanized air pipe is recommended.
4. The joints must be sealed with a metallic tape or Silastic™ suitable for temperatures up to 350°F.
5. A minimum of 12 inches of straight vent pipe is recommended after the exhaust connection and before any elbows.
6. Vertical combustion air pipes should be fitted with a tee, drip leg and clean-out cap to prevent any moisture in the combustion air pipe from entering the unit.
7. To reduce condensation, insulate any vent runs greater than 5 feet.
8. All vent pipe connections should be made with at least three corrosion resistant sheet metal screws.
9. Refer to the National Fuel Gas Code for additional piping guidelines.

NOTE

Vent piping is supplied by others and not supplied by manufacturer.

NOTE

The drip leg should be cleaned out periodically during the heating season.

NOTE

Clearances from combustible material for indoor units are determined by the National Fuel Gas Code and/or other local codes.

Venting Methods

There are three venting methods for indoor mounted units. For each method, the units can be vented horizontally through an exterior wall or vertically through the roof. Specific venting instructions are provided for each method and shown in the following pages. Construct the vent system as shown in these instructions. Refer to your unit specific submittal to determine the applicable venting option.

The venting method options are:

Standard Indoor Venting

- uses building air for combustion
- vents exhaust to outdoors
- one exterior roof or wall penetration

Separated Combustion Concentric Venting

- uses outside air for combustion
- vents exhaust to outdoors
- one exterior roof or wall penetration

Separated Combustion 2-Pipe Venting

- uses outside air for combustion
- vents exhaust to outdoors
- two exterior roof or wall penetrations

NOTE

For each method, the units can be vented horizontally through an exterior wall or vertically through the roof. Refer to the specific venting instructions for your unit. Construct the vent system as shown in these instructions.

Installation of Standard Indoor Venting

Standard Indoor Venting uses one penetration through an exterior wall or roof for venting the flue exhaust. The combustion air is supplied from the air inside the building. Units must not be installed in a potentially explosive, flammable, or corrosive atmosphere. To prevent premature heat exchanger failure, do not locate unit where chlorinated, halogenated or acid vapors are present.

When units are installed in tightly sealed buildings, provisions should be made to supply an adequate amount of infiltration air from the outside. The rule of thumb is that an opening of one square inch should be provided for every 1000 BTUs per hour of input rating.

Vent terminals must be used. Construct the vent system as shown in the drawings. Reference the Vent Pipe Diameter table and Exhaust Vent Pipe table for additional details.

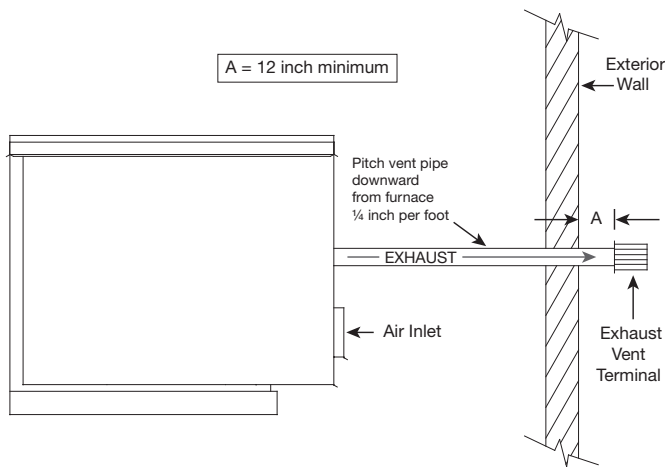

Standard Indoor Venting - Horizontal

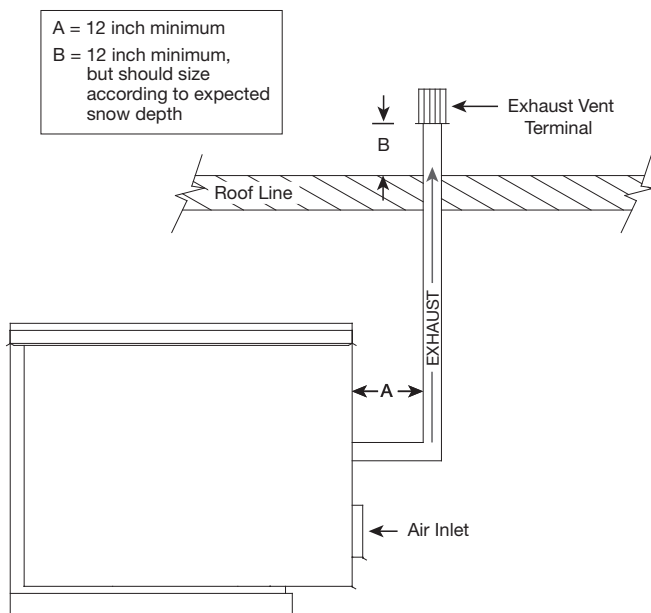

Standard Indoor Venting - Vertical

Vent Pipe Diameter

Select the vent pipe diameter. Use only the specified pipe diameter.

Furnace Size (MBH)	Exhaust Pipe Diameter (inches)
75 - 175	4
200 - 400	6

Installing Exhaust Vent Pipe

Install the vent pipe with a minimum downward slope (from the unit) of 1/4-inch per foot (horizontal venting only). Securely suspend the pipe from overhead structures at points no greater than 3 feet apart. The minimum vent length is 5 feet for horizontal and 10 feet for vertical. The maximum vent length is 70 feet. The total equivalent vent length must include elbows. The equivalent length of a 4 inch elbow is 6 feet and the equivalent length of a 6 inch elbow is 10 feet. Attach the vent terminal to the end of the exhaust pipe.

Vent Length	Minimum (feet)	Maximum (feet)
Horizontal	5	70
Vertical	10	70

Installation of Concentric Venting (General)

Concentric venting allows the exhaust pipe and combustion air pipe to pass through a single hole in the roof or wall of the building. A concentric venting adapter (CVA) is required for concentric venting.

The concentric venting adapter is designed for indoor installations and should never be installed on the exterior of the building.

The exhaust pipe must terminate with the vent terminal. For horizontal venting, the combustion air pipe must terminate with the combustion air guard. For vertical venting, the combustion air pipe must terminate with the inlet terminal. Depending on what was ordered, one of these vent terminals will be provided in the optional venting kit along with the concentric venting adapter (CVA).

If venting vertically through the roof, refer to the vertical concentric venting instructions. If venting horizontally through the wall, refer to the horizontal concentric venting instructions.

NOTE

Vent piping is supplied by others and not supplied by manufacturer.

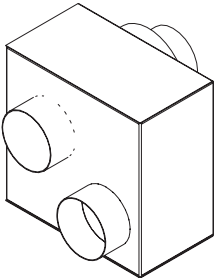

CVA-4
4-inch Concentric Venting Adapter

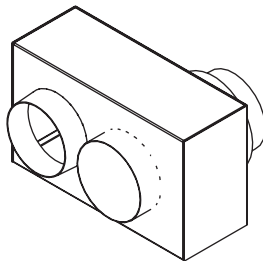

CVA-6
6-inch Concentric Venting Adapter

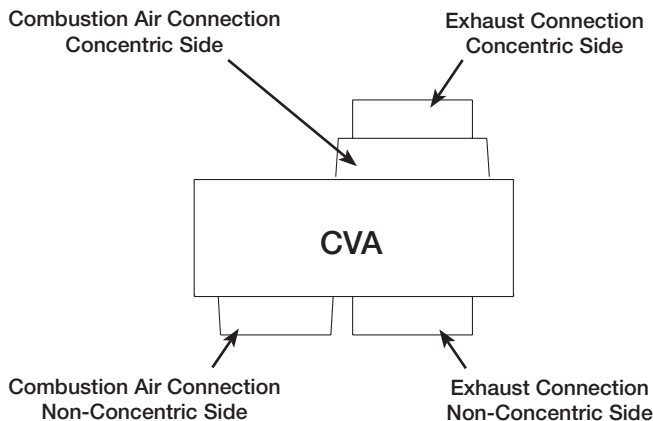

Top View

Concentric Venting – Horizontal

Refer to the diagram below for venting on horizontal concentric systems. Maintain at least 12 inches from the combustion air inlet guard to the exhaust vent terminal (Dim. B). To prevent water from running into the combustion air pipe and to allow for easy installation of the combustion air inlet guard, the combustion air pipe must terminate at least 2 inches from the exterior surface of the outside wall (Dim. A).

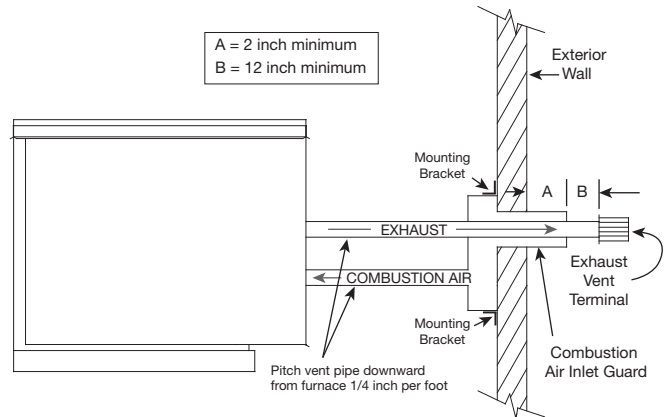

Vent Connection Diameter

Vent terminals must be used (one vent terminal included with each furnace). Construct the vent system as shown in the drawings and refer to the table for the correct vent connection diameters.

Furnace Size (MBH)	Non-Concentric Vent Connection Diameter		Concentric Vent Connection Diameter	
	Exhaust (inches)	Combustion Air (inches)	Exhaust (inches)	Combustion Air (inches)
75-175	4	4	4	6
200-400	6	6	6	8

Vent Length

Refer to table for minimum and maximum vent lengths. The total equivalent vent length must include elbows. The equivalent length of a 4 inch elbow is 6 feet and the equivalent length of a 6 inch elbow is 10 feet.

Vent Length	Minimum (feet)	Maximum (feet)
Horizontal	5	70

1. Determine Venting Location

Determine the location of the concentric venting adapter (CVA) based on any clearances that must be maintained (follow all codes referenced in these instructions).

2. Attach Mounting Brackets

Attach field-supplied, corrosion resistant mounting brackets to the CVA using corrosion resistant sheet metal screws.

3. Install Exhaust Pipe

Slide the exhaust pipe through the CVA. Provide enough exhaust piping to pass through the wall (or floor) and provide the minimum clearance of 12 inches between the exhaust pipe termination and the combustion air intake. With all required clearances satisfied, attach the exhaust pipe to the CVA.

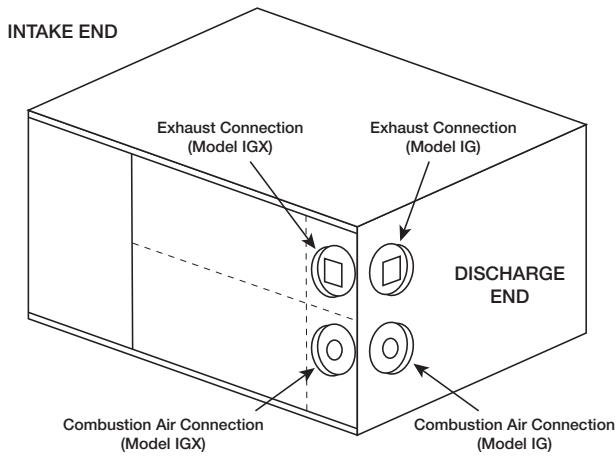

4. Install Combustion Air Pipe

Attach a field-supplied combustion air pipe to the concentric side of the CVA.

Be sure to provide enough combustion air piping to pass through the wall and provide the minimum clearance of 2 inches between the combustion air intake and the exterior surface of the outside wall.

Be sure to maintain the minimum clearance of 12 inches between the exhaust pipe termination and the combustion air intake.

5. Install CVA Assembly

Place the CVA assembly through the wall and verify that all minimum clearance requirements as specified in these instructions are met. Secure the CVA assembly to the wall with corrosion resistant sheet metal screws through the mounting brackets.

6. Attach CVA Assembly to Unit

Attach the exhaust pipe to the unit's combustion exhaust. Using an additional combustion air pipe, connect the unit's combustion air supply intake to the combustion air connection on the CVA.

7. Install Combustion Air Inlet Guard and Exhaust Vent Terminal

Slide the combustion air inlet guard over the exhaust pipe and fasten it to the combustion air pipe. Attach the exhaust vent terminal to the discharge end of the exhaust piping on the outside of the building.

8. Seal Opening

Seal the opening between the wall and the air intake pipe using an appropriate method.

Concentric Venting – Vertical

Refer to the diagram below for venting on vertical concentric systems. Maintain at least 12 inches between the top of the combustion air inlet terminals and the bottom of the exhaust terminal. (Dim. B).

The bottom of the combustion air intake pipe must terminate above the snow line or at least 12 inches above the roof, whichever is greater.

A tee with cleanout must be provided on the combustion air and exhaust pipe to prevent debris from entering the heat exchanger.

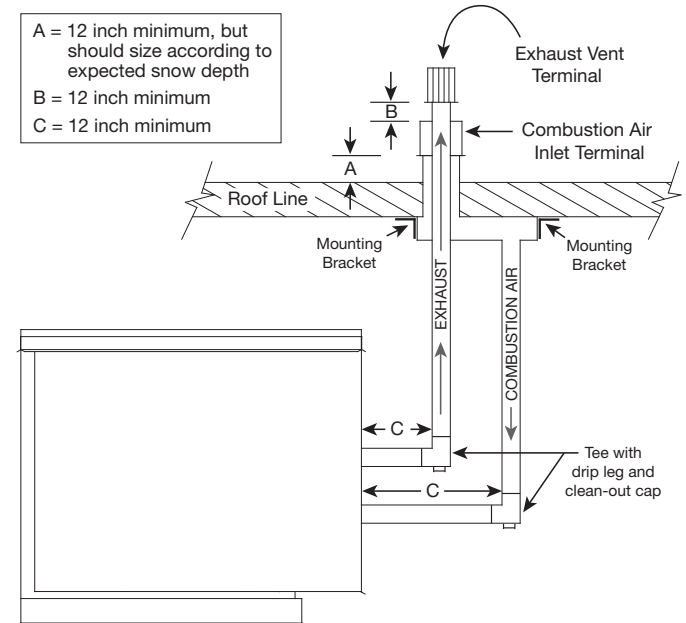

Vent Connection Diameter

Vent terminals must be used. Construct the vent system as shown in the drawings and refer to the table for the correct vent connection diameters.

Furnace Size (MBH)	Non-Concentric Vent Connection Diameter		Concentric Vent Connection Diameter	
	Exhaust (inches)	Combustion Air (inches)	Exhaust (inches)	Combustion Air (inches)
75-175	4	4	4	6
200-400	6	6	6	8

Vent Length

Refer to table for minimum and maximum vent lengths. The total equivalent vent length must include elbows. The equivalent length of a 4 inch elbow is 6 feet and the equivalent length of a 6 inch elbow is 10 feet.

Vent Length	Minimum (feet)	Maximum (feet)
Vertical	10	70

1. Determine Venting Location

Determine the location of the concentric venting adapter (CVA) based on any clearances that must be maintained (follow all codes referenced in these instructions).

2. Attach Mounting Brackets

Attach field-supplied, corrosion resistant, mounting brackets to the CVA using corrosion resistant sheet metal screws.

3. Install Exhaust Pipe

Slide the exhaust pipe through the CVA. Provide enough exhaust piping to pass through the roof and provide the minimum clearance of 12 inches between the exhaust pipe termination and the combustion air intake. With all required clearances satisfied, attach the exhaust pipe to the CVA.

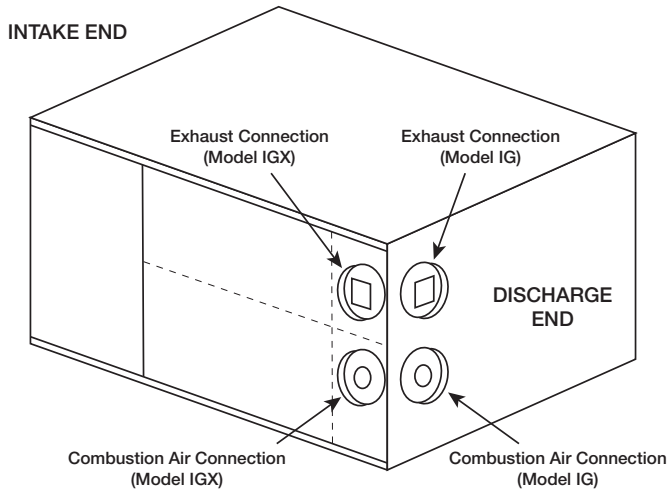

4. Install Combustion Air Pipe

Attach a field-supplied combustion air pipe to the concentric side of the CVA.

Be sure to provide enough combustion air piping to pass through the roof and provide the minimum clearance of 12 inches between the combustion air intake and the exterior surface of the roof. This clearance may need to be increased to allow for snow accumulation.

Be sure to maintain the minimum clearance of 12 inches between the exhaust pipe termination and the combustion air intake.

5. Install CVA Assembly

Place the CVA assembly through the roof and verify that all minimum clearance requirements as specified in these instructions are met. Secure the CVA assembly to the ceiling with corrosion resistant sheet metal screws through the mounting brackets.

6. Attach CVA Assembly to Unit

Attach the exhaust pipe to the unit's combustion exhaust. Using an additional combustion air pipe, connect the unit's combustion air supply intake to the combustion air connection on the CVA.

Be sure to include the required tee's with drip legs and clean-outs.

7. Install Combustion Air Inlet Guard and Exhaust Vent Terminal

Slide the combustion air terminal over the vent pipe and fasten it to the combustion air pipe. Attach the exhaust vent terminal to the discharge end of the exhaust piping.

8. Seal Opening

Seal the opening between the roof line and the air intake pipe using an appropriate method.

Installation of Two Pipe Venting – Horizontal

Refer to the diagram below for venting on horizontal concentric systems. Maintain at least 12 inches of clearance between the exhaust pipe termination and the exterior surface of the exterior wall (Dim. A).

The combustion air pipe must be a minimum of 12 inches from the exhaust pipe and 24 inches from the exterior surface of the outside wall (Dim. B).

A minimum of 1 inch and a maximum of 48 inches of building wall thickness is required for separated combustion vent pipe.

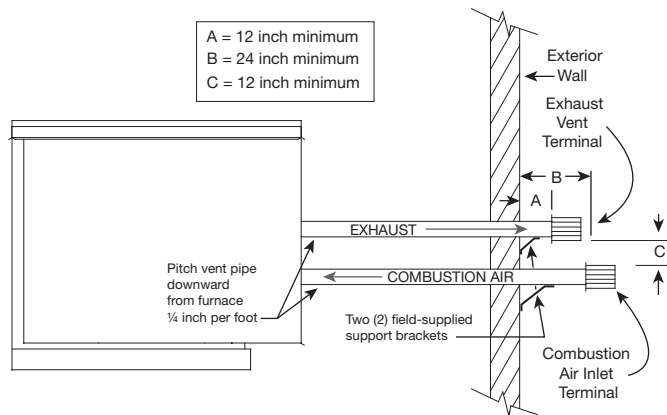

Vent Connection Diameter

Vent terminals must be used. The optional vent kit includes two terminals. Construct the vent system as shown in the drawings and refer to the table for the correct vent connection diameters.

Furnace Size (MBH)	Exhaust (inches)	Combustion (inches)
75 - 175	4	4
200 - 400	6	6

Vent Length

Refer to table for minimum and maximum vent lengths. The minimum vent length is 5 feet and the maximum vent length is 50 feet. The total equivalent vent length must include elbows. The equivalent length of a 4 inch elbow is 6 feet and the equivalent length of a 6 inch elbow is 10 feet.

Vent Length	Minimum (feet)	Maximum (feet)
Horizontal	5	50

1. Install Exhaust Pipe

Run an exhaust pipe from the unit's combustion exhaust through the exterior wall to the outdoors. The exhaust pipe must terminate at least 12 inches from the outside surface of the outside wall. Attach exhaust vent terminal to the end of the exhaust pipe. Using field-supplied mounting brackets, support the exhaust pipe as needed.

2. Install Combustion Air Pipe

Run a combustion air pipe from the unit's combustion air intake through the exterior wall to the outdoors. The combustion air pipe must terminate at least 12 inches from the combustion vent pipe and 24 inches from the exterior surface of the outside wall. Attach the combustion air inlet guard to the end of the combustion air pipe. Using field-supplied mounting brackets, support the combustion air pipe as needed.

3. Seal Wall Openings

Using an appropriate method, seal the wall openings around the piping.

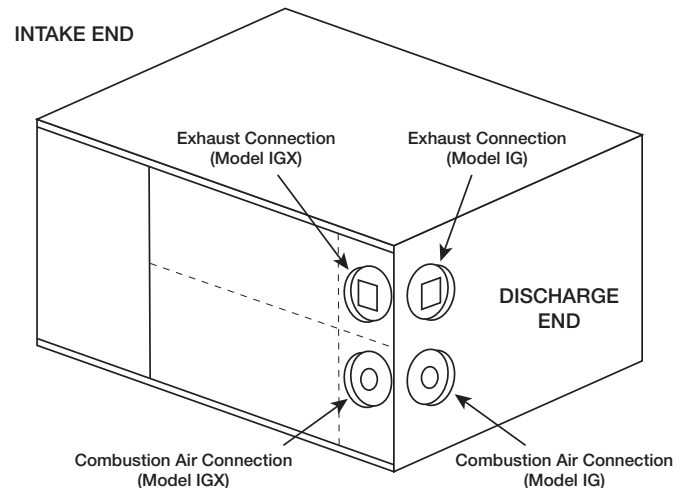

Installation of Two Pipe Venting – Vertical

Refer to the diagram below for venting on vertical concentric systems. The combustion air pipe must terminate at least 12 inches above the roof. This clearance may need to be increased to accommodate for snow accumulation. The exhaust must terminate at least 12 inches above and 12 inches horizontally from the combustion air inlet.

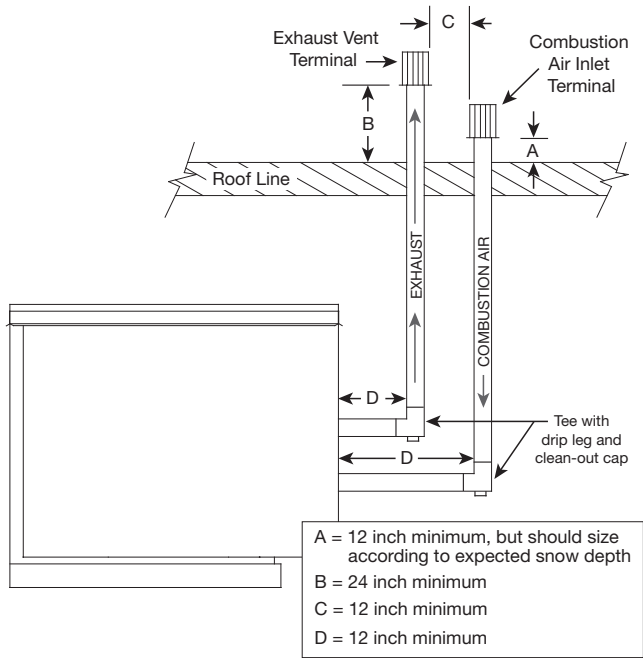

Vent Connection Diameter

Vent terminals must be used. Construct the vent system as shown in the drawings and refer to the table for the correct vent connection diameters.

Furnace Size (MBH)	Exhaust (inches)	Combustion (inches)
75 - 175	4	4
200 - 400	6	6

Vent Length

Refer to table for minimum and maximum vent lengths. The minimum vent length is 10 feet and the maximum vent length is 70 feet. The total equivalent vent length must include elbows. The equivalent length of a 4 inch elbow is 6 feet and the equivalent length of a 6 inch elbow is 10 feet.

Vent Length	Minimum (feet)	Maximum (feet)
Vertical	10	70

1. Install Exhaust Pipe

Run an exhaust pipe from the unit's combustion exhaust through the roof to the outdoors. The exhaust pipe must terminate at least 12 inches above the outside surface of the roof. This clearance may need to be increased to accommodate snow accumulation. Attach the exhaust vent terminal to the end of the exhaust pipe.

2. Install Combustion Air Pipe

Run a combustion air pipe from the unit's combustion air intake through the roof to the outdoors. The combustion air pipe must terminate at least 12 inches horizontally and vertically from the combustion exhaust pipe and at least 24 inches from the exterior surface of the roof. These clearances may need to be increased to accommodate for expected snow accumulation. Attach the combustion air terminal to the end of the combustion air pipe.

3. Seal Roof Penetration

Using an appropriate method, seal the roof openings around the vent pipes.

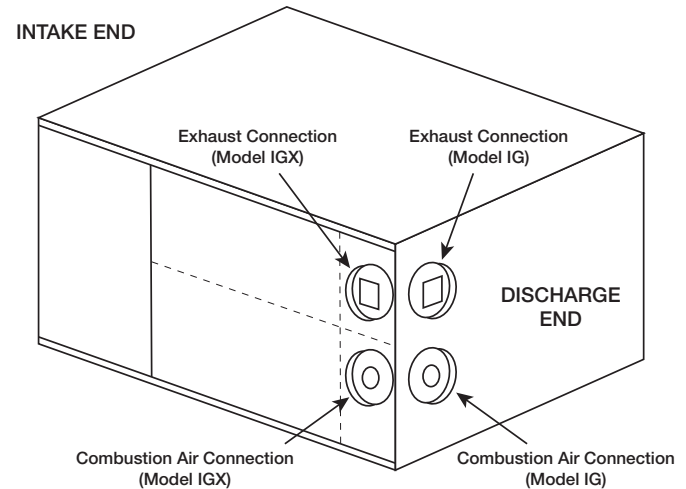

Installation - Electrical Wiring

IMPORTANT

Before connecting power to the unit, read and understand the following instructions and wiring diagrams. Complete wiring diagrams are attached on the inside of the control center door(s).

IMPORTANT

All wiring should be done in accordance with the latest edition of the National Electrical Code ANSI/NFPA 70 and any local codes that may apply. In Canada, wiring should be done in accordance with the Canadian Electrical Code.

CAUTION

If replacement wire is required, it must have a temperature rating of at least 105°C, except for energy cut-off or sensor lead wire which must be rated to 150°C.

IMPORTANT

The equipment must be properly grounded. Any wiring running through the unit in the airstream must be protected by metal conduit, metal clad cable or raceways.

DANGER

High voltage electrical input is needed for this equipment. This work should be performed by a qualified electrician.

CAUTION

Any wiring deviations may result in personal injury or property damage. Manufacturer is not responsible for any damage to, or failure of the unit caused by incorrect final wiring.

IMPORTANT

Manufacturer's standard control voltage is 24 VAC. Control wire resistance should not exceed 0.75 ohms (approximately 285 feet total length for 14 gauge wire; 455 feet total length for 12 gauge wire). If the resistance exceeds 0.75 ohms, an industrial-style, plug-in relay should be wired in place of the remote switch. The relay must be rated for at least 5 amps and have a 24 VAC coil. Failure to comply with these guidelines may cause motor starters to chatter or not pull in, resulting in contactor failures and/or motor failures.

1. Determine the Size of the Main Power Lines

The unit's nameplate states the voltage and the unit's total MCA. The main power lines to the unit should be sized accordingly. The nameplate is located on the outside of the unit on the control panel side.

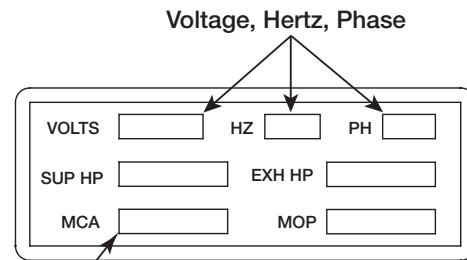

Unit's Total MCA

Electrical Nameplate

2. Provide the Opening(s) for the Electrical Connections

Electrical openings vary by unit size and arrangement and are field-supplied.

3. Connect the Main Power

Connect the main power lines to the disconnect switch and main grounding lug(s). Torque field connections to 20 in.-lbs.

4. Wire the Optional Convenience Outlet

The convenience outlet requires a separate 115V power supply circuit. The circuit must include short circuit protection which may need to be supplied by others.

5. Wire the Optional Accessories

Reference the ladder diagram on the inside of the control center door for correct wiring of the following accessories:

- Selectra Stat
- Room Override
- Blower Switch
- Heat Switch
- Indicating Lights
- Dirty Filter Indicator
- TSCP
- KSCP
- Economizer Activator
- Room Stat

NOTE

Wiring to the Selectra Stat or room override should be in separate conduit or run with shielded cable.

NOTE

The TSCP and KSCP remote panels have number-to-number wiring.

6. Wire the Evaporative Cooler (optional)

Reference the ladder diagram on the inside of the control center door for correct wiring of the pump and the optional water valves.

NOTE

Large evaporative coolers may require a separate power supply.

7. Install Economizer Sensors (optional)

All economizer options (EC) require an outdoor air temperature or enthalpy sensor to be field installed inside of the weatherhood and field wired to terminals SO+ and SO- on the economizer.

Economizer options EC-3 and EC-4 require an outdoor air temperature or enthalpy sensor to be field installed in the return air duct and field wired to terminals SR+ and SR- on the economizer.

The sensors are provided by the factory and ship with the unit.

8. Install Discharge Air Sensor (optional)

For units with 8:1, 16:1 or 24:1 staged turndown, install the discharge air sensor at least three duct diameters downstream of the heat exchanger. The discharge air sensor can be found in the unit's control center.

9. Install DDC Interface (Optional)

Some units may use an external signal from a building management system to control the dampers and/or discharge air temperature. Reference the unit ladder diagram for the correct wiring.

Installation of Gas Piping

IMPORTANT

All gas piping must be installed in accordance with the latest edition of the National Fuel Gas Code ANSI/Z223.1 and any local codes that may apply. In Canada, the equipment shall be installed in accordance with the Installation Code for Gas Burning Appliances and Equipment (CGA B149) and Provincial Regulations for the class. Authorities having jurisdiction should be consulted before installations are made.

IMPORTANT

All piping should be clean and free of any foreign material. Foreign material entering the gas train can cause damage.

WARNING

All components of this or any other gas fired heating unit must be leak tested prior to placing the unit into operation. A soap and water solution should be used to perform this test. NEVER test for gas leaks with an open flame.

IMPORTANT

Do NOT connect the unit to gas types other than what is specified and do NOT connect the unit to gas pressures that are outside of the pressure range shown on the label.

WARNING

When leak testing pressures equal to or less than 14 in. wg (3.5 kPa), first close the field-installed shutoff valve to isolate the unit from the gas supply line.

NOTE

When connecting the gas supply, the length of the run must be considered in determining the pipe size to avoid excessive pressure drop. Refer to a Gas Engineer's Handbook for gas pipe capacities.

NOTE

Each furnace has a single 3/4-inch connection.

1. Determine the Supply Gas Requirements

The unit's nameplate states the requirements for the gas being supplied to the unit.

Minimum gas pressure for maximum output

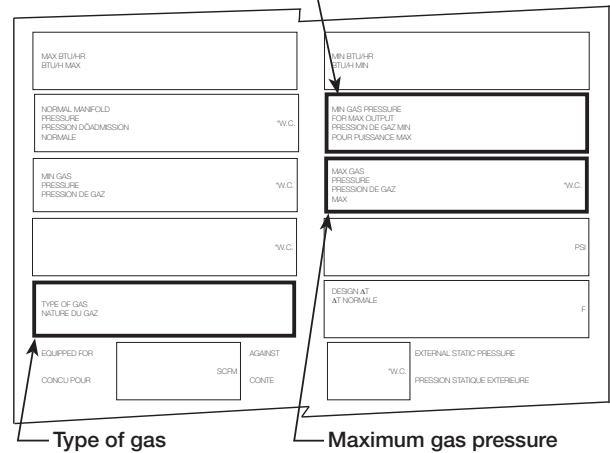

Indirect Gas Nameplate

2. Install Additional Regulator if Required

When the supply gas pressure exceeds the maximum gas pressure shown on the unit's nameplate, an additional regulator (by others) is required to reduce the pressure. The regulator must have a listed leak limiting device or it must be vented to the outdoors.

	Supply Gas Pressure Range (in. wg)	
	Minimum	Maximum
Natural	6	14
LP	10	14

3. Connect the Supply Gas Line

A manual shut off valve (gas cock), 1/8 inch plugged test port and 6 inch drip leg must be installed prior to the gas train. The valve and the test port must be accessible for the connection of a test gauge.

Supply gas connections must be made by a qualified installer and are not furnished by manufacturer.

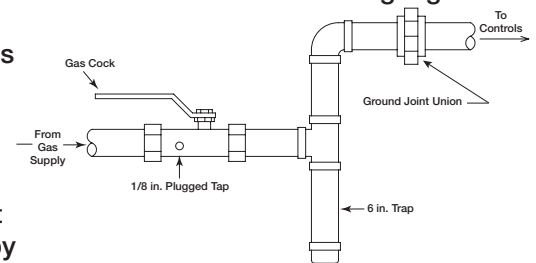

Supply Gas Line

4. Test the System for Leaks

Check both the supply lines and the factory piping for leaks. Apply a soap and water solution to all piping and watch for bubbling which indicates a leak.

WARNING

NEVER test for a gas leak with an open flame.

WARNING

The factory piping has been checked for leaks, but should be rechecked due to shipping and installation.

Installation - Evaporative Cooler Piping (optional)

Evaporative Cooling with Recirculating Pump

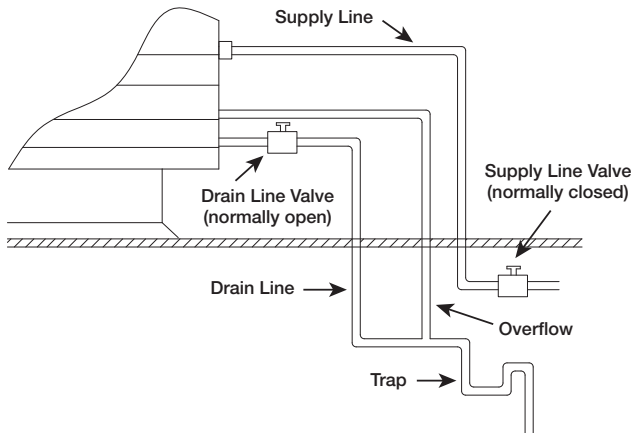

Recirculating Evaporative Piping

IMPORTANT

All supply solenoids, valves and all traps must be below the roofline or be otherwise protected from freezing.

IMPORTANT

The supply line should be of adequate size and pressure to resupply the amount of water lost due to bleed-off and evaporation. The drain line should be the same size or larger than the supply line.

CAUTION

Provisions must be taken to prevent damage to the evaporative cooling section during freezing conditions. The sump, drain lines and supply lines must be drained prior to freezing conditions or an alternate method must be used to protect the lines and media.

1. Install the Water Supply Line

Supply line opening requirements vary by unit size and arrangement and are field-supplied. Connect the water supply line to the float valve through the supply line opening in the evaporative cooling unit. Install a manual shutoff valve in the supply line.

2. Install the Drain Line

Connect an unobstructed drain line to the drain and overflow connections on the evaporative cooler. A manual shut off valve (by others) is required for the evaporative cooler drain line. A trap should be used to prevent sewer gas from being drawn into the unit.

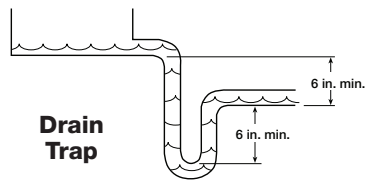

3. Check/Adjust Water Level

Check the water level in the sump tank. The water level should be above the pump intake and below the overflow. Adjust the float as needed to achieve the proper water level.

Evaporative Cooling with Auto Drain and Fill

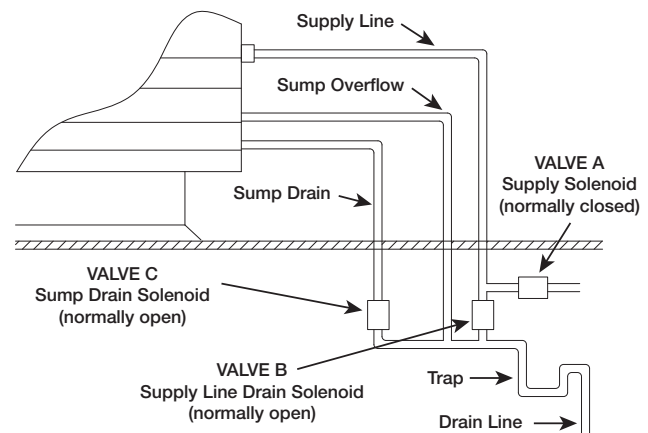

Auto Drain & Fill Evaporative Piping

IMPORTANT

The supply line should be of adequate size and pressure to resupply the amount of water lost due to bleed-off and evaporation. The drain line should be the same size or larger than the supply line.

CAUTION

All solenoid valves and traps must be installed below the roof to protect the supply water line from freezing. If they cannot be installed below the roof, an alternative method must be used to protect the lines from freezing.

IMPORTANT

The supply solenoid (Valve A) is NOT the same as the drain solenoids (Valve B and Valve C). Make sure to use the proper solenoid for each location. Check your local code requirements for proper installation of this type of system.

Auto Drain & Flush Valves (when provided by manufacturer)

Assembly Number	Mfg. Part Number	ASCO™ Part Number	Solenoid Type	De-Energized Position	Diameter	Qty.
852178	461262	8210G2	Supply	Closed	1/2 inch (12.7 mm)	1
	461263	8262G262	Supply Line Drain	Open	1/4 inch (6.35 mm)	1
	461264	8210G35	Sump Drain	Open	3/4 inch (19.05 mm)	1

Part numbers subject to change.

1. Install the Water Supply Line

Supply line opening requirements vary by unit size and arrangement and are field-supplied. Connect the water supply line to the float valve through the supply line opening in the evaporative cooling unit. Install the 1/2 inch normally closed solenoid (Valve A) in the supply line. Install the 1/4 inch normally open solenoid (Valve B) between the supply line and the drain line as shown.

2. Install the Drain Line

Connect an unobstructed drain line to the sump drain overflow connection. Install the 3/4 in. normally open solenoid (Valve C) between the sump drain connection and the drain line. A trap should be used to prevent sewer gas from being drawn into the unit. Refer to Drain Trap drawing.

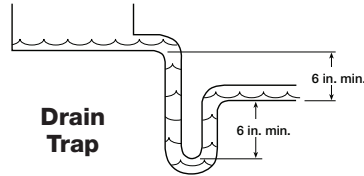

3. Check/Adjust Water Level

Check the water level in the sump tank. The water level should be above the pump intake and below the overflow. Adjust the float as needed to achieve the proper water level.

Installation of Water Wizard™ (optional)

Evaporative Cooling with the Water Wizard™

NOTE

The following instructions are provided for evaporative coolers equipped with the Water Wizard™ only. Additional instructions are provided for evaporative coolers equipped with the auto drain and fill or bleed-off.

WARNING

Disconnect and lock-out all power and gas before performing any maintenance or service to the unit. Failure to do so could result in serious injury or death and damage to equipment.

Water Wizard™ Valves (when provided by manufacturer)

Unit Model	Assembly Number	Mfg. Part Number	ASCO™ Part Number	Solenoid Type	De-Energized Position	Diameter	Qty.
IGX - H12/H22 IGX - H32 (<9000 cfm)	852370	461262	8210G2	Supply	Closed	1/2 inch (12.7 mm)	1
		383086	8210G34	Supply Line Drain	Open	1/2 inch (12.7 mm)	1
IGX - H32 (≥9000 cfm)	852371	383088	8210G9	Supply	Closed	3/4 inch (19.05 mm)	1
		383086	8210G34	Supply Line Drain	Open	1/2 inch (12.7 mm)	1

Part numbers subject to change.

1. Install Normally Closed Supply Line/Solenoid

Connect the water supply line to the manual supply valve in the unit. Install the supply solenoid in the supply line, upstream of the manual supply valve and below the roofline.

2. Install Normally Open Drain Line/Solenoid

Connect the drain line to the supply line between the manual supply valve and the supply solenoid. Install a drain solenoid in the drain line, below the roof line. A trap should be installed in the drain line.

NOTE

Solenoid(s) may be provided by manufacturer (if ordered) or by others.

CAUTION

Any wiring deviations may result in personal injury or property damage. Manufacturer is not responsible for any damage to or failure of the unit caused by incorrect final wiring.

Installation of Water Wizard™, continued

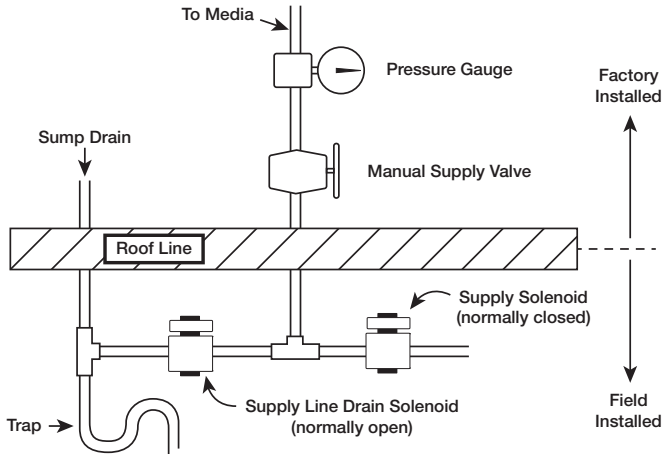

Water Wizard™ Installation

3. Wire the Solenoid(s)

Wire the supply line solenoid and drain solenoid as shown on the unit's wiring diagram in the control center.

4. Wire the Temperature Sensor

If the evaporative cooler shipped separate from the unit, the temperature sensor must be wired. The sensor wire is bundled inside the discharge end of the evaporative cooler. Wire the sensor wire to terminals AI2 and AIC on the terminal strip in the unit's control center.

NOTE

The Water Wizard™ start-up must be completed for proper performance.

Installation - Direct Expansion (DX) Coil Piping (optional)

IMPORTANT

Guidelines for the installation of direct expansion cooling coils have been provided to ensure proper performance and longevity of the coils. These are general guidelines that may have to be tailored to meet the specific requirements of any one job. As always, a qualified party or individual should perform the installation and maintenance of any coil. Protective equipment such as safety glasses, steel toe boots and gloves are recommended during the installation and maintenance of the coil.

IMPORTANT

All field-brazing and welding should be performed using high quality materials and an inert gas purge (such as nitrogen) to reduce oxidation of the internal surface of the coil.

IMPORTANT

All field-piping must be self-supporting and flexible enough to allow for the thermal expansion of the coil.

1. Locate the Distributor(s) by Removing the Distributor Access Panel



Distributor Access Panel

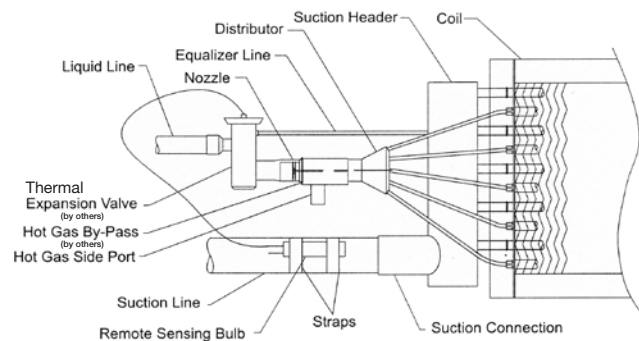

Installation with Hot Gas Bypass

2. Verify Nozzle Placement

Inspect the refrigerant distributor and verify that the nozzle is in place. The nozzle is generally held in place by a retaining ring or is an integral part of the distributor itself.

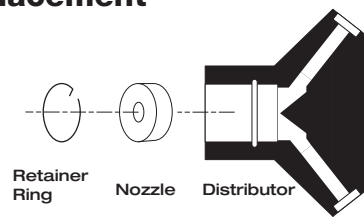

Nozzle Placement

NOTE

If a hot gas bypass kit was provided by others, refer to the manufacturer's instructions.

3. Install Suction Line

Install suction line(s) from the compressor to the suction connection(s) which are stubbed through the side of the cabinet.

4. Install the Liquid Line and Thermal Expansion Valve (TEV) (By Others)

Liquid line openings vary by coil size and circuiting and are field-supplied. Follow the TEV recommendations for installation to avoid damaging the valve. If the valve is externally equalized, use a tubing cutter to cut off the plugged end of the factory-installed equalizer line. Use a de-burring tool to remove any loose metal from the equalizer line and attach it to the TEV. If the valve is internally equalized, the factory-installed equalizer line can be left as is.

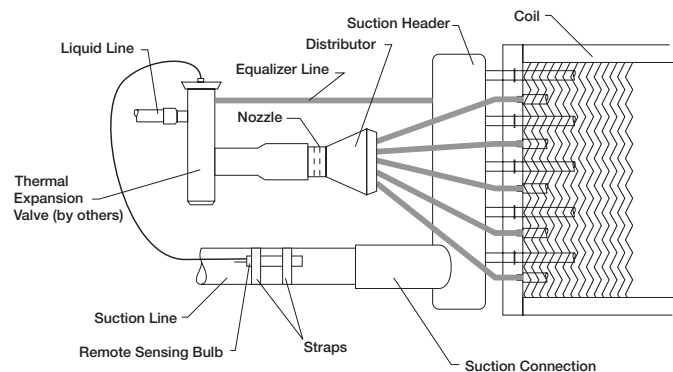

General Installation

5. Mount the Remote Sensing Bulb (By Others)

The expansion valve's remote sensing bulb should be securely strapped to the horizontal run of the suction line at the 3 or 9 o'clock position and insulated.

6. Check Coil Piping for Leaks

Pressurize the coil to 100 psig with dry nitrogen or other suitable gas. The coil should be left pressurized for a minimum of 10 minutes. If the coil holds the pressure, the hook-up can be considered leak free. If the pressure drops by 5 psig or less, re-pressurize the coil and wait another 10 minutes. If the pressure drops again, there is likely one or more small leaks which should be located and repaired. Pressure losses greater than 5 psig indicate a large leak that should be isolated and repaired.

7. Evacuate and Charge the Coil

Use a vacuum pump to evacuate the coil and any interconnecting piping that has been open to the atmosphere. Measure the vacuum in the piping using a micron gauge located as far from the pump as possible. Evacuate the coil to 500 microns or less and then close the valve between the pump and the system. If the vacuum holds to 500 microns or less

for one minute, the system is ready to be charged or refrigerant in another portion of the system can be opened to the coil. A steady rise in microns would indicate that moisture is still present and that the coil should be further vacuumed until the moisture has been removed.

NOTE

Failure to obtain a high vacuum indicates a great deal of moisture or a small leak. Break the vacuum with a charge of dry nitrogen or other suitable gas and recheck for leaks. If no leaks are found, continue vacuuming the coil until the desired vacuum is reached.

8. Install the Drain Line

Connect an unobstructed drain line to the drain pan. A trap should be used to prevent sewer gas from being drawn into the unit.

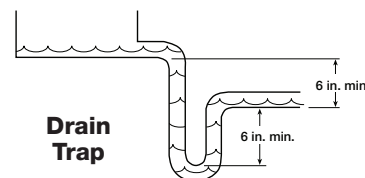

IMPORTANT

All traps must be installed below the roof line or be otherwise protected from freezing.

Installation of Chilled Water Coil Piping (optional)

IMPORTANT

Guidelines for the installation of the cooling coil have been provided to ensure proper performance of the coils and their longevity. These are general guidelines that may have to be tailored to meet the specific requirements of any one job. As always, a qualified party or individual should perform the installation and maintenance of the coil. Protective equipment such as safety glasses, steel toe boots and gloves are recommended during the installation and maintenance of the coil.

When installing couplings, do not apply undue stress to the connection. Use a backup pipe wrench to avoid breaking the weld between the coil connection and the header.

All field-piping must be self-supporting. System piping should be flexible enough to allow for the thermal expansion and contraction of the coil.

1. Verify Coil Hand Designation

Check the coil hand designation to ensure that it matches the system.

Coils are generally plumbed with the supply connection located on the bottom of the leaving air-side of the coil and the return connection at the top of the entering air-side of the coil. This arrangement provides a counter flow heat exchanger and positive coil drainage.

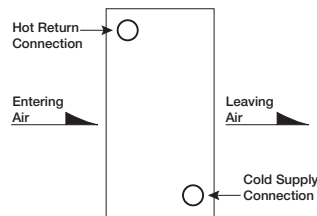

2. Check the Coil for Leaks

Pressurize the coil to 100 psig with dry nitrogen or other suitable gas. The coil should be left pressurized for a minimum of 10 minutes. If the coil holds the pressure, the hook-up can be considered leak free. If the pressure drops by 5 psig or less, re-pressurize the coil and wait another 10 minutes. If the pressure drops again, there is likely one or more small leaks which should be located and repaired. Pressure losses greater than 5 psig indicate a large leak that should be isolated and repaired.

3. Connect the Supply & Return Lines

Connect the supply and return lines as shown above.

4. Install the Drain Line

Connect an unobstructed drain line to the drain pan. A trap should be installed to prevent sewer gas from being drawn into the unit.

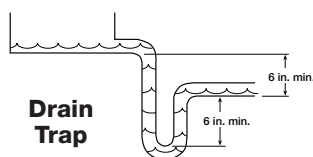

IMPORTANT

All traps must be installed below the roof line or be otherwise protected from freezing.

Installation of Building Pressure Control (optional)

1. Mount Pressure Tap

Using the factory provided bracket, mount the pressure tap to the outside of the unit.

Choose a location out of the prevailing winds and away from supply or exhaust fans to assure accurate readings.



2. Run Pressure Tap Lines

Run a pressure tap line from the pressure tap on the outside of the unit to the low pressure tap on the back of the photohelic gauge. Run a second pressure tap line from the high pressure tap on the back of the photohelic gauge to the space. Fifty feet of tubing is supplied with the unit.

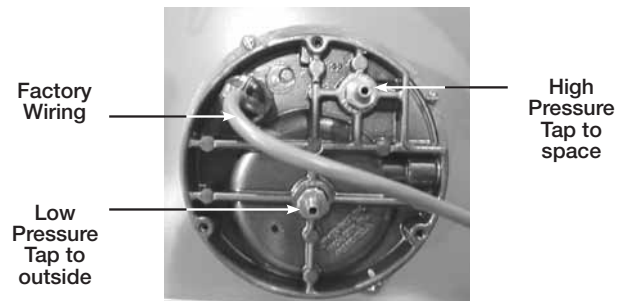

Connections for Photohelic Gauge

3. Set the Building Pressure

The pressure gauge is used to set the desired building pressure. The pressure is set by adjusting the knobs for the upper and lower pressure limits. Typical settings are 0.0 in. wg for the lower and 0.10 in. wg for the upper pressure setting.

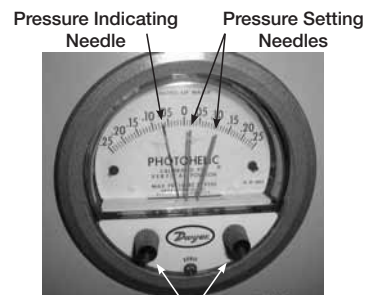

Pressure Setting Knobs

Typical Photohelic Gauge Settings

Start-Up - Blower

Refer to the Start-Up Checklist in the Reference Section Before Proceeding Further!

Pre Start-Up Check

Rotate the fan wheel by hand and make sure no parts are rubbing. Check the V-belt drive for proper alignment and tension (a guide for proper belt tension and alignment is provided in the Belt Maintenance section). Check fasteners, set screws, and locking collars on the fan, bearings, drive, motor base, and accessories for tightness.

WARNING

Disconnect and lock-out all power and gas before performing any maintenance or service to the unit. Failure to do so could result in serious injury or death and damage to equipment.

SPECIAL TOOLS REQUIRED

- Voltage Meter (with wire probes)
- Amperage Meter
- Micro Amp Meter
- Pressure Gauges – (refrigerant)
- Tachometer
- Thermometer
- Incline manometer or equivalent

WARNING

Check the housing, blower, and ductwork for any foreign objects before running the blower.

1. Check the Voltage

Before starting the unit, compare the supplied voltage, hertz, and phase with the unit and motor's nameplate information.

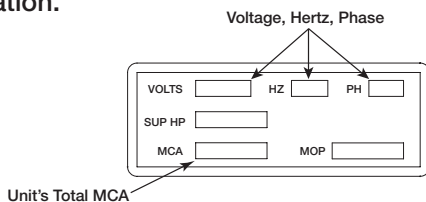

Electrical Nameplate

2. Check the Blower Rotation

Open the blower access door and run the blower momentarily to determine the rotation.

Arrows are placed on the blower scroll to indicate the proper direction or reference the example shown.

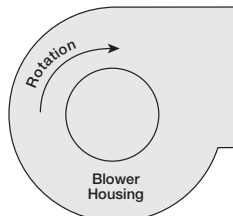

Blower Rotation

NOTE

To reverse the rotation on three phase units, disconnect and lock-out the power, then interchange any two power leads.

NOTE

To reverse the rotation on single phase units, disconnect and lock-out the power, then rewire the motor per the manufacturer's instructions.

IMPORTANT

If the blower is rotating in the wrong direction, the unit will move some air, but will not perform as designed. Be sure to perform a visual inspection to guarantee the correct blower rotation.

3. Check for Vibration

Check for unusual noise, vibration or overheating of the bearings. Reference the Troubleshooting section for corrective actions.

IMPORTANT

Excessive vibration may be experienced during the initial start-up. Left unchecked, it can cause a multitude of problems including structural and/or component failure.

IMPORTANT

Generally, fan vibration and noise is transmitted to other parts of the building by the ductwork. To minimize this undesirable effect, the use of heavy canvas duct connectors is recommended.

4. Motor Check

Measure the motor's voltage, amps and RPM. Compare to the specifications. Motor amps can be reduced by lowering the motor RPM or increasing system static pressure.

IMPORTANT

Additional starters and overloads may be provided in the make-up air control center for optional exhaust blowers. Any additional overloads must be checked for proper voltage, amps and RPMs.

5. Air Volume Measurement & Check

Measure the unit's air volume (CFM) and compare it with its rated air volume. If the measured air volume is off, adjust the fan's RPM by changing/adjusting the drive.

NOTE

The most accurate way to measure the air volume is by using a pitot traverse method downstream of the blower. Other methods can be used but should be proven and accurate.

IMPORTANT

Changing the air volume can significantly increase the motor's amps. If the air volume is changed, the motor's amps must be checked to prevent overloading the motor.

NOTE

To ensure accuracy, the dampers are to be open when measuring the air volume.

6. Set-up Optional Components

Adjust the settings on the optional components. See the Control Center Layout in the Reference section for location of optional components.

- Heating Inlet Air Sensor
Typical setting: 60-70°F
- Cooling Inlet Air Sensor
Typical setting: 75°F
- Building Freeze Protection
Typical setting: 5 minutes; 45°F
- Dirty Filter Gauge
Typical setting: Settings vary greatly for each unit. See Reference section for adjusting information.

NOTE

If your unit is equipped with a 4:1 modulation or 8:1 staged control, the inlet air sensor and building freeze protection may be included in the furnace controller. If this is the case, instructions for setting the inlet air sensor and building freeze protection are included in the Furnace Start-Up.

Start-Up - Furnaces (all units)

IMPORTANT

For the unit to function properly, all stage or modulation valves must be set for high and low fire.

NOTE

There are five furnace control options available. Be sure to refer to the specific instructions for your control type.

IMPORTANT

Multi furnace units may use a combination of the available control options. Each furnace must be set-up per the specific instructions for its control type.

IMPORTANT

Multi furnace units will use one stage or electronic modulation controller per unit and one or two ignition controller(s) per furnace. Each furnace will have its own gas valve(s). Each valve must be set for high and low fire.

NOTE

To force the unit to light for set-up purposes, the heat switch must be closed or jumpered out. See the Ladder Diagram on the inside of the control center door for proper terminals to jumper out.

NOTE

If the unit is equipped with an independent inlet air sensor (not incorporated into the stage or modulation controller), the unit will not light unless the outside air temperature is less than the inlet air sensor setting. If the outside air is greater than the inlet air sensor setting, turn the setting to its maximum position. When set-up is complete, reset the inlet air sensor to the proper temperature. If the unit is equipped with a stage or electronic modulation controller that includes an inlet air sensor function, the inlet air sensor will be overridden when the unit is forced to high fire.

Available Control Options

Single Furnace Units

1:1 Staged	one 1-stage furnace
2:1 Staged	one 2-stage furnace
8:1 Staged	one 8-stage furnace
2:1 Electronic Modulation	one 2:1 modulating furnace
4:1 Electronic Modulation	one 4:1 modulating furnace

Two Furnace Units

1:1 Staged	two independent 1-stage furnaces
2:1 Staged	two independent 1-stage furnaces
4:1 Staged	two independent 2-stage furnaces
16:1 Staged	one 8-stage and one 1-stage furnace
8:1 Electronic Modulation	one 4:1 modulating and one 2-stage furnace

Three Furnace Units

1:1 Staged	three independent 1-stage furnaces
3:1 Staged	three independent 1-stage furnaces
6:1 Staged	three independent 2-stage furnaces
24:1 Staged	one 8-stage and two 1-stage furnaces
12:1 Electronic Modulation	one 4:1 modulating, one 2-stage and one 1-stage furnace

Start-Up - Single Stage Control

1. Send Unit to High Fire

Send the unit to high fire by setting the temperature selector to its maximum setting.

Temperature Selector



2. Check the High Fire Manifold Pressure

Using a manometer, measure the burner manifold pressure at the manifold pressure test port. Refer to the Gas Train Layout in the Reference section for the test port location.

The pressure on high fire should be 3-1/2 in. wg for natural gas and 10 in. wg for LP gas.

	Single Stage Manifold Pressure (in. wg)	
	Natural Gas	LP
High Fire	3-1/2	10

If needed, use the high fire adjustment screw on the staged gas valve to adjust the high fire manifold pressure. Counterclockwise rotation will decrease the gas pressure and clockwise rotation will increase the gas pressure.

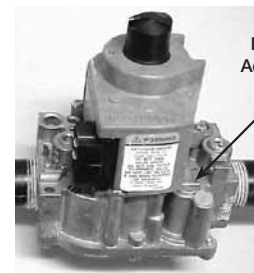

High Fire Adjustment

3. Reset the Temperature Setting

Reset the temperature setting on the temperature selector to the desired setting.

Start-Up - 2:1 Staged Control

1. Send Unit to High Fire

Send the unit to high fire by setting the temperature selector to its maximum setting.



2. Check the High Fire Manifold Pressure

Using a manometer, measure the burner manifold pressure at the manifold pressure test port. Refer to the Gas Train Layout in the Reference section for the test port location.

The pressure on high fire should be 3-1/2 in. wg for natural gas and 10 in. wg for LP gas.

If needed, use the high fire adjustment screw on the combination gas valve to adjust the high fire manifold pressure. Counterclockwise rotation will decrease the gas pressure and clockwise rotation will increase the gas pressure.

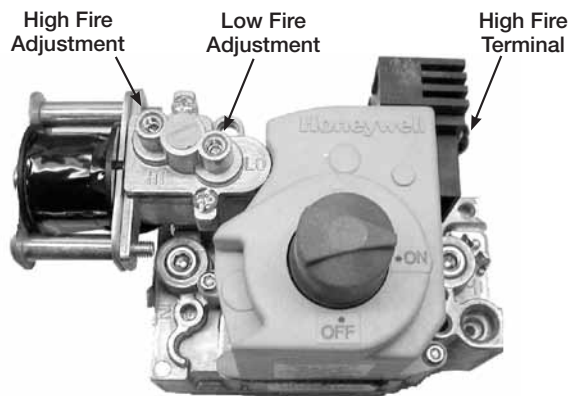

3. Send Unit to Low Fire

Remove and isolate the wire from the high fire terminal on the combination gas valve to send the unit to low fire.

4. Check the Low Fire Manifold Pressure

Using a manometer, measure the burner manifold pressure at the manifold pressure test port. Refer to the Gas Train Layout in the Reference section for the test port location.

The pressure on low fire should be 7/8 in. wg for natural gas and 2-1/2 in. wg for LP gas.

	Two Stage Manifold Pressure (in. wg)	
	Natural Gas	LP
Low Fire	7/8	2-1/2
High Fire	3-1/2	10

If needed use the low fire adjustment screw on the combination gas valve to adjust the low fire manifold pressure. Counterclockwise rotation will decrease the gas pressure and clockwise rotation will increase the gas pressure. Once the low fire manifold pressure is set, reattach the high fire wire to the high fire terminal.

5. Reset the Temperature Setting

Reset the temperature setting on the temperature selector to the desired setting.

Start-Up - 8:1 Staged Control

IMPORTANT

8:1 staged furnaces use two manifolds and two staged gas valves per furnace. The high and low fire manifold pressure must be checked and properly set on each manifold.

IMPORTANT

Confirm that the discharge air sensor is installed in the duct, at least three duct diameters downstream of the furnace.

1. Send the Unit to High Fire

For the furnace to light, the heat switch must be closed or jumpered out. Reference the unit ladder diagram for proper terminals to jumper.

To send the unit to high fire, press and hold the Up, Down and Enter keys. The middle LED light, L2, will flash on the screen when the unit is forced to high fire.

The unit will remain at high fire until the Function key is pressed (middle LED light, L2, will stop flashing).

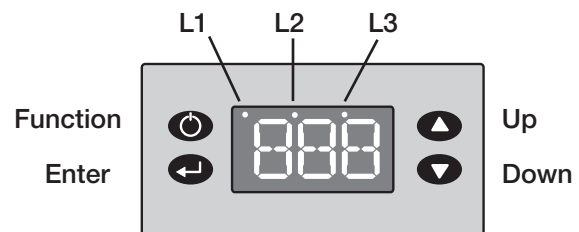

WARNING

Once the unit is forced to high fire, it will remain at high fire until the Function key is pressed.

NOTE

Forcing the unit to high fire during warm or hot weather conditions may cause the high limit switch to trip. If the switch trips, it will reset once the discharge air temperature has reached a safe level.

2. Check the High Fire Manifold Pressure

Using a manometer, measure the high fire burner manifold pressure for each furnace at the pressure test port. Refer to the Gas Train Layout in the Reference section for the test port location.

The recommended high fire manifold pressure is 3-1/2 in. wg for natural gas and 10 in. wg for LP gas.

If needed, adjust the high fire screws on each staged gas valve to set both high fire manifold pressures. Counterclockwise rotation will decrease the gas pressure and clockwise rotation will increase the gas pressure.

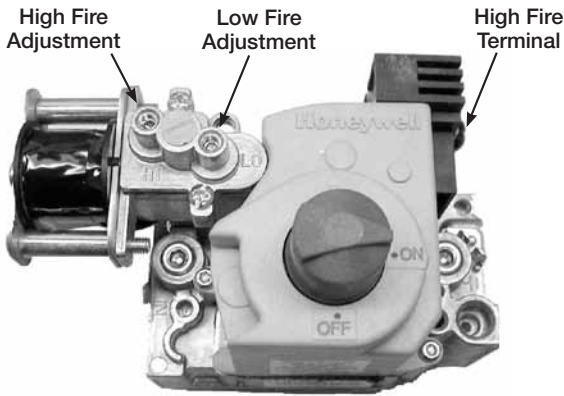

3. Send the Unit to Low Fire

Disconnect and isolate the wire from the high fire terminal to send the unit to low fire.

4. Check the Low Fire Manifold Pressure

Measure each valve's low fire manifold pressure.

The recommended low fire manifold pressure is 7/8 in. wg for natural gas and 2-1/2 in. wg for LP.

If needed, use the low fire adjustment screw on each staged gas valve to properly set both low manifold settings. Counterclockwise rotation will decrease the gas pressure and clockwise rotation will increase the gas pressure.

When the low fire manifold pressure is properly set, reattach the disconnected wire to the high fire terminal, allow the heat switch to close or remove the jumper.

	Eight Stage Manifold Pressure (in. wg)	
	Natural Gas	LP
Low Fire	7/8	2-1/2
High Fire	3-1/2	10

WARNING

Once the high and low fire have been set, be sure to press the Function key to end high fire mode. The middle LED light, L2, will stop flashing when high fire mode is off.

NOTE

Step 5-7 are for adjusting the discharge air setting. The discharge air temperature setting is factory set to the recommended 70°F. Only adjust the setting if needed.

NOTE

After modifying a setting, the Enter key must be pressed to save the change. If the Enter key is not pressed the display will return to the setpoints menu without saving the change.

5. Access the Setpoints Menu

Press and hold the Function key for three seconds to access the Setpoints Menu. The display will read "SET."



6. Access the Discharge Air Temperature Setting

Using the Up or Down key, scroll through the Setpoints Menu until the display reads "dtS", then press the Enter key. The display will change to the discharge air temperature setting.

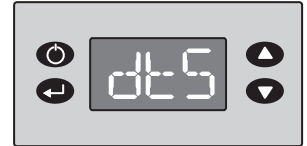

7. Edit the Setting

Use the Up or Down key to change the discharge air temperature setting. When the correct setting is displayed, press the Enter key to save the setting and return to the Setpoints Menu.

NOTE

Steps 8 - 9 are provided for adjusting the inlet air set point. The inlet air sensor is preset to the factory recommended 65°F, only adjust if needed.

NOTE

The inlet air sensor monitors the temperature of the inlet air. If the inlet air is above the sensor's set point, the inlet air sensor shuts off the furnace and continues to supply the warm outside air.

8. Access the Inlet Air Sensor Setting

From the Setpoints Menu, use the Up or Down key to navigate through the menu options until the display reads "iAS". Once the display reads "iAS", press the Enter key. The display will change to the inlet air sensor setting.

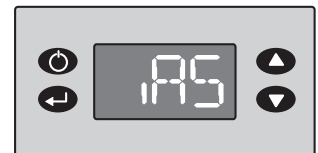

9. Edit the Setting

Use the Up or Down key to change the inlet air setting. When the correct setting is displayed, press the Enter key to save the setting and return to the Setpoints Menu.

NOTE

After modifying a setting, the Enter key must be pressed to save the change. If the Enter key is not pressed, the display will return to the Setpoints Menu without saving the change.

NOTE

Steps 10 - 11 are provided for adjusting the room override setting. Only adjust the setting if the room override function is desired.

NOTE

The room override function temporarily changes the discharge air temperature to the room override setting if the room thermostat is not satisfied.

10. Access the Room Override Setting

From the Setpoints Menu, use the Up or Down key to navigate through the menu options until the display reads “rot.” Once the display reads “rot,” press the Enter key. The display will change to the room override setting.



NOTE

The room override function requires a field-supplied thermostat to be installed in the space and to be wired between terminal 31 and 32 in the unit's control center. Reference the unit ladder diagram.

11. Edit the Setting

Use the Up or Down key to change the room override setting. When the correct setting is displayed, press the Enter key to save the setting and return to the Setpoints Menu.

Start-Up - 2:1 Electronic Modulation

1. Send Unit to High Fire

Turn the temperature selector to its maximum setting to send the unit to high fire.

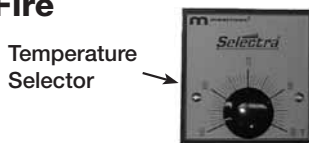

2. Check the High Fire Manifold Pressure

With the unit at high fire, use a manometer to measure the burner manifold pressure at the manifold pressure test port. See the Gas Train Layout in the Reference section for the manifold pressure test port location.

The recommended high fire manifold pressure is 3-1/2 in. wg for natural gas and 10 in. wg for LP gas.

If needed, use the high fire adjustment screw on the shut-off gas valve to adjust the high fire manifold pressure. Counterclockwise rotation will decrease the gas pressure and clockwise rotation will increase the gas pressure.

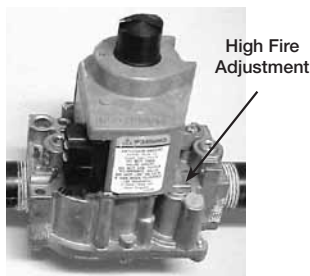

3. Send Unit to Low Fire

Remove and isolate one wire from the modulating gas valve terminal to send the unit to low fire.

4. Check the Low Fire Manifold Pressure

With the unit at low fire, use a manometer to measure the burner manifold pressure at the manifold pressure test port. See the Gas Train Layout in the Reference section for the manifold pressure test port location.

The recommended low fire manifold pressure is 7/8 in. wg for natural gas and 2-1/2 in. wg for LP gas.

	2:1 Manifold Pressure (in. wg)	
	Natural Gas	LP
Low Fire	7/8	2-1/2
High Fire	3-1/2	10

If needed, use the low fire adjustment screw on the modulating gas valve to adjust the low fire manifold pressure. Counterclockwise rotation will decrease the gas pressure and clockwise rotation will increase the gas pressure.

Once the low fire is set, reattach the disconnected wire to the modulating valve and reset the temperature selector.

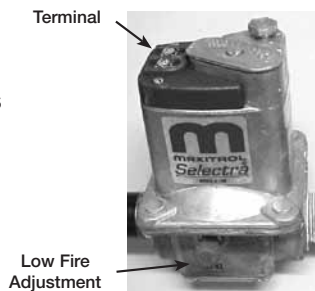

NOTE

The low fire manifold pressure should always be rechecked after adjusting the high fire.

NOTE

Once the high and low fire manifold pressures are properly set, reset the discharge air temperature to the desired setting.

Start-Up - 4:1 Electronic Modulation

1. Send the Unit to High Fire

To send the unit to high fire, press and hold the Up, Down and Enter keys. The unit will remain at high fire until the Function key is pressed.

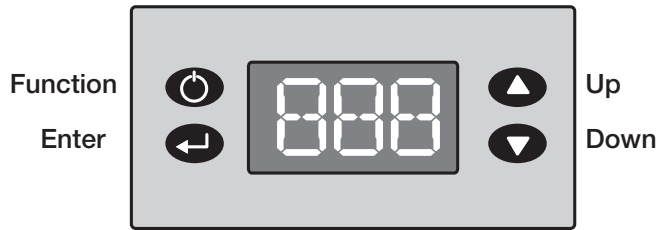

WARNING

If the unit is forced to high fire, it will remain at high fire until the Function key is pressed.

NOTE

After modifying a setting, the Enter key must be pressed to save the change. If the Enter key is not pressed the display will return to the Program Menu without saving the change.

NOTE

Forcing the unit to high fire in mild weather conditions may cause the high limit switch to trip. If the switch trips, it will reset once the discharge air temperature is at a safe level.

2. Check the High Fire Manifold Pressure

Before setting high fire on the EXA valve, turn the regulator screw on the combination valve all the way in (increase pressure).

Using a manometer, measure the high fire manifold pressure at the pressure test port. Refer to the Gas Train Layout in the Reference section for the test port location.

The recommended high fire manifold pressure is 3-1/2 in. wg for natural gas and 10 in. wg for LP gas.

If needed, adjust the high fire screw on the shut-off valve to set the high fire manifold pressure. Counterclockwise rotation will decrease the gas pressure and clockwise rotation will increase the gas pressure.

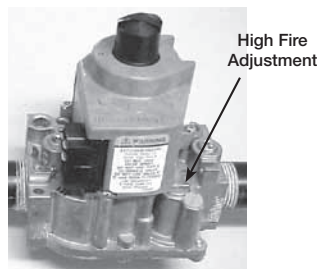

To enter the high fire setting mode, press and hold button #1 until the LED lights solid red. Release. The valve is now in the high fire setting mode.

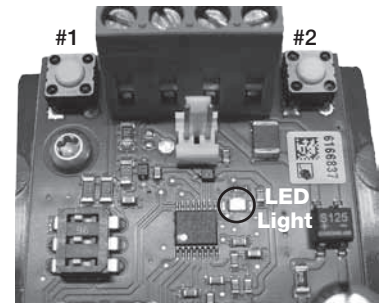

Press or hold button #2 to decrease gas flow. Each button press equates to the minimum available step size and will decrease flow slowly. Holding the button down auto-steps and eliminates the need to continuously press the button. Use this feature to rapidly decrease the flow.

Press or hold button #1 to increase gas flow. Each button press equates to the minimum available step size and will increase flow slowly. Holding the button down auto-steps and eliminates the need to continuously press the button. Use this feature to rapidly decrease the flow.

High fire setting should be 3.5 in. wg for natural gas and 10.0 in. wg for LP gas.

To save high fire setting, simultaneously hold button #1 and #2 until the LED turns off.

NOTE

Controls left in the high fire setting mode will default to the current setting after 5 minutes of inactivity.

3. Exit High Fire Mode

Press the Function key to exit high fire mode.

4. Send Unit to Low Fire

Remove the cover on the modulating gas valve. Press and hold button #2 until the LED light blinks red; release. The unit is now in low fire.

5. Check the Low Fire Manifold Pressures

With the unit at low fire, use a manometer to check the manifold pressure. Refer to the Gas Train Layout in the Reference section for the test port location.

The recommended low fire manifold pressure is 1/3 in. wg for natural gas and 1.0 in. wg for LP gas.

	4:1 Modulation Manifold Pressure (in. wg)	
	Natural Gas	LP
Low Fire	1/3	1
High Fire	3-1/2	10

To adjust the low fire gas pressure, use button #1 and #2 on the gas valve. Button #1 will increase the gas pressure, while button #2 will decrease the gas pressure. Each time the button is pressed, it corresponds to the minimum available step size and will slowly change the gas pressure. Holding the button down will rapidly change the gas pressure. To save the low fire setting, simultaneously hold buttons 1 and 2 until the LED turns off.

Note: If the valve remains in the low fire setting mode for more than five (5) minutes, it will revert back to its previous setting.

NOTE

The following steps are for adjusting the discharge air setting. The discharge air temperature setting is factory set to the recommended 70°F. Only adjust the setting if needed.

6. Access the Setpoints Menu

Press and hold the Function key for three seconds to access the Setpoints Menu. The display will read “SET” when Setpoints Mode is active.



7. Access the Discharge Air Temperature Setting

Use the Up or Down keys to scroll through the Setpoints Menu options until the display reads “dtS” then press the Enter key. The display will change to the discharge air temperature setting.



8. Edit the Setting

Use the Up or Down keys to change the discharge air temperature setting. When the correct setting is displayed, press the Enter key to save the setting and return to the Setpoints Menu.

NOTE

After modifying a setting, the Enter key must be pressed to save the change. If the Enter key is not pressed the display will return to the Setpoints Menu without saving the change.

NOTE

Steps 9 thru 10 are provided for adjusting the inlet air set point. The inlet air sensor is preset to the factory recommended 60°F, only adjust if needed.

NOTE

The inlet air sensor monitors the temperature of the inlet air. If the inlet air is above the sensor's set point, the inlet air sensor shuts off the furnace and continues to supply the warm outside air.

9. Access the Inlet Air Sensor Setting

From the Setpoints Menu, use the Up or Down key to navigate through the menu options until the display reads “iAS.” Once the display reads “iAS”, press the Enter key. The display will change to the inlet air sensor setting.



10. Edit the Setting

Use the Up or Down key to edit the inlet air setting. When the correct setting is displayed, press the Enter key to save the setting and return to the Setpoints menu.

NOTE

Steps 11 and 12 are provided for adjusting the room override setting. Only adjust the setting if the room override function is desired.

NOTE

The room override function temporarily changes the discharge air temperature to the room override setting if a room thermostat is not satisfied.

11. Access the Room Override Setting

From the Setpoints Menu, use the Up or Down key to navigate through the menu options until the display reads “rot.” Once the display reads “rot,” press the Enter key. The display will change to the room override setting.



NOTE

The room override function requires a field-supplied thermostat to be installed in the space and to be wired between terminal 31 and 32 in the unit's control center.

12. Edit the Setting

Use the Up or Down key to change the room override setting. When the correct setting is displayed, press the Enter key to save the setting and return to the Setpoints menu.

NOTE

After modifying a setting, the Enter key must be pressed to save the change. If the Enter key is not pressed the display will return to the Setpoints Menu without saving the change.

Start-Up - Economizer (optional)

NOTE

To prevent premature heat exchanger failure, do not locate units where chlorinated, halogenated, or acid vapors are present.

NOTE

Units with an economizer are designed for either 0-30% outside air (HV-1), 31-75% outside air (HV-2) or 100% return air (HV-3). Refer to the CAPS submittal for the unit's ventilation type.

NOTE

HV-1 and HV-2 use economizer controls (EC) or (MB).

NOTE

Economizer control may use outside air temperature reference (EC-1), outside enthalpy reference (EC-2), differential temperature reference (EC-3) or differential temperature reference (EC-4).

NOTE

Economizer control may use a potentiometer (MB-1), 2-10 VDC signal (MB-2), 4-20mA signal (MB-3) or a manual quadrant (MB-4).

1. Verify Sensor Installation

All economizer options (EC) require an outdoor air temperature or enthalpy sensor to be field-installed inside of the weatherhood and field-wired to terminals SO+ and SO- on the economizer.

Economizer options EC-3 and EC-4 require an outdoor air temperature or enthalpy sensor to be field-installed in the return air duct and field-wired to terminals SR+ and SR- on the economizer.

Verify that all economizer sensors needed for your application are properly installed and wired.

2. Set Minimum Outside Air

Set the minimum outside air position. HV-1 is designed for 0-30% outside air and HV-2 is designed for 31-75% outside air.

All economizer options, EC-1, EC-2, EC-3 and EC-4 and option MB-1 use a potentiometer to set the minimum outside air damper position. The potentiometer is located on the economizer for options EC-1, EC-2, EC-3 and EC-4. The potentiometer may be factory-mounted in the unit control center or field-mounted in the space for option MB-1.

MB-2 and MB-3 use an external signal from a building management system to position the dampers.

MB-4 uses a manual quadrant located on the inlet damper to position the dampers.

IMPORTANT

The outside air volume must be measured and compared to the total air volume when setting the minimum outside air. The minimum outside air should never be set based on the inlet damper or potentiometer position.

3. Set the Enthalpy Changeover Set Point (optional)

If using an economizer, the enthalpy changeover setting must be set. If differential temperature or differential enthalpy control is used, set the enthalpy changeover set point to *D*. If outside air temperature or enthalpy reference is used, set the enthalpy changeover set point to the desired setting from the following table.

Enthalpy Changeover Setting	
Setting	Changeover Temperature* (°F)
A	73
B	70
C	67
D	63

*Temperature at 50% relative humidity, see the Honeywell W7212 Economizer instructions for set points at other humidities

NOTE

For options EC-3 and EC-4 the enthalpy changeover set point is the temperature at which the economizer will send the dampers to the minimum outside air position.

4. Program Optional Room Stat

Program the optional room stat. Separate detailed instructions for programming the room stat ship with the optional room stat.

Start-Up - Evaporative Cooling (optional)

1. Check the Installation

The media may have been removed during installation, so its orientation should be double checked. The media should be installed with the steeper flute angle sloping down towards the entering air side.

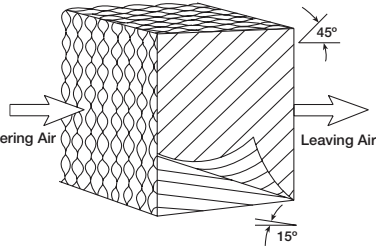

Verify that the stainless steel caps and distribution headers are in place. The headers should be located over the media towards the entering air side. The caps should be placed over the headers.

2. Check the Pump Filter

Check that the pump filter is around the pump inlet.

3. Fill the Sump and Adjust the Float

Turn on the water supply and allow the sump tank to fill. Adjust the float valve to shut-off the water supply when the sump is filled to within 1 in. of the bottom of the overflow.

4. Break-In the Media

Open the bleed-off valve completely and saturate the media with the blower(s) off for no less than 20 minutes.

NOTE

A jumper will need to be installed in the control center to power the evaporative pumps with the blower(s) off. Reference the unit's ladder diagram to determine proper terminals.

5. Check the Flow Rate

The pumps should provide enough water to saturate the media in 45 to 60 seconds. Consult the factory, if adequate flow is not achieved.

6. Adjust the Water Bleed-Off Rate

The water bleed-off rate is dependent on the water's mineral content. The bleed-off should be adjusted based on the media's mineral deposits after two weeks of service.

7. Set the Optional Auto Drain and Fill

Set the auto drain, fill timer and temperature settings. Temperature is typically set to 45°F / 7°C
Timer settings are: t1: 1.0, 10min
t2: 0.4, 60h

8. Put the Unit into Service

Remove the jumper, and energize the blower(s). Verify proper operation.

IMPORTANT

Check the media for minerals after two weeks of service and adjust the bleed-off rate accordingly.

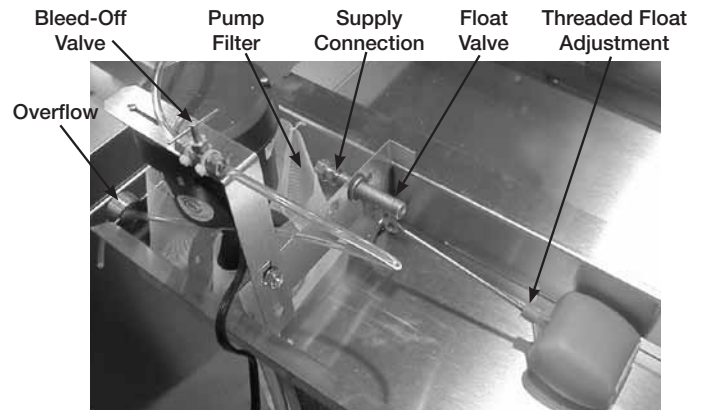

Evaporative Cooler Set-Up

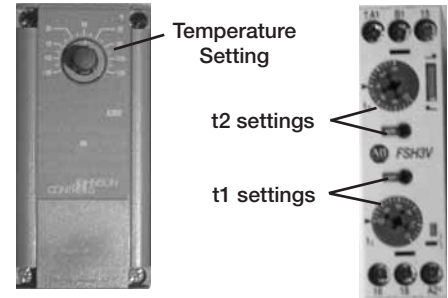

Evaporative Freeze Protection

Evaporative Timer

Start-Up - Water Wizard™ (optional)

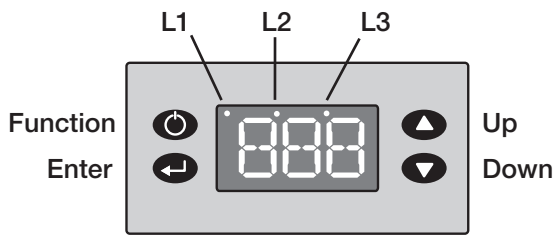

Water Wizard™ User Interface
Key Function Description

1. Open the Solenoid

Confirm that the manual water supply valve is closed. Press and hold the Function key for one second. L3 will begin blinking (short on, long off), indicating that Flow Test Mode is active and the supply solenoid is open.

WARNING

Opening the manual supply valve will allow water to pass to the media. Be sure the sump is safely draining before opening the manual supply valve.

NOTE

The manual supply valve ships closed and must be adjusted for proper performance.

2. Set the Water Pressure

With the solenoid open, set the supply water pressure to the correct setting from the following tables. Use the manual supply valve to adjust the supply pressure. A pressure gauge is provided between the manual supply valve and the media.

NOTE

The recommended water pressure for the model IGX is set based on media width, model IG is set based on air volume. A table is provided for each. Be sure to refer to the correct table.

IGX Housing	Media Width (inches)	Water Pressure (in. wg)
12	30	20
22	43¾	36
	48	42
	60	61
32	66	72
	96*	42

*Multiple media sections. Value represents total media width.

Model IG CFM Range	Water Pressure (in. wg)
800 – 3500	50
3501 – 7000	74

3. Break-In Media

Leave the supply solenoid open to saturate and break-in media for 20 minutes with the blower off.

4. Close Solenoid

With the pressure set, press the Function key for one second to deactivate Flow Test Mode and allow the supply solenoid to close.

5. Check Media

Start the cooling cycle and check the media after one hour of operation. If the media is continuously dry or if too much water is draining from the sump tank, refer to Troubleshooting, Water Wizard™.

NOTE

Steps 6 through 8 are provided to adjust the minimum cooling temperature. The minimum cooling is preset to the factory recommended 75°F (24°C). Only adjust if needed.

NOTE

The inlet air sensor function overrides and shuts down the evaporative cooler if the outside temperature falls below the minimum cooling temperature.

6. Enter Program Mode

Press and hold the Enter key for three seconds. The display will read “Pro” when Program Mode is active.

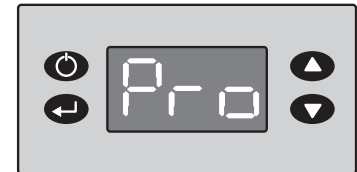

Program Display

7. Adjust the Minimum Cooling Temperature

While in the Program Menu, use the Up and Down keys to navigate the Menu Options until “toF” is displayed. Press the

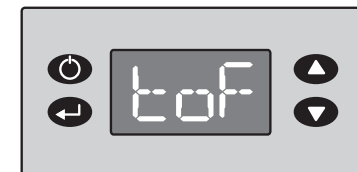

Minimum Cooling Temperature Display

Enter key to access the selected Menu Option setting.

Use the Up and Down keys to adjust the Minimum Cooling Temperature as needed. Press the Enter key to save the Minimum Cooling Temperature setting and return to the Program Menu.

NOTE

The Enter key must be pressed to save the new minimum cooling temperature.

8. Exit Program Mode

After ten seconds of idle time the controller will exit Program Mode.

NOTE

The Freeze Temperature is preset to the factory recommended 45°F. Steps 9-11 should only be completed if the Freeze Temperature needs adjustment.

NOTE

The Freeze Temperature is the temperature at which the supply solenoid closes and the drain solenoid opens to drain the supply line, preventing possible freeze damage. A drain solenoid is required for this option.

9. Enter Program Mode

Press and hold the Enter key for three seconds. The display will read “Pro” when Program Mode is active.



Program Display

10. Adjust the Freeze Temperature

While in Program Mode, use the Up and Down keys to navigate through the Menu Options until “Frt” is displayed. Press the Enter key to access the selected Menu Option setting.



Freeze Temperature Display

Use the Up and Down keys to adjust the Freeze Temperature setting as needed. Press the Enter key to set the Freeze Temperature and return to the Program Menu.

NOTE

The Enter key must be pressed to save the new freeze temperature.

11. Exit Program Mode

After ten seconds of idle time the controller will exit Program Mode.

Operation - Water Wizard™ (optional)

Drain Mode locks open the drain solenoid and drains the supply line between the supply solenoid and the media. To activate Drain Mode, simultaneously press the Function and Enter keys (L2 will light). To deactivate Drain Mode and unlock the drain solenoid, simultaneously press the Function and Enter keys again.

Flow Test Mode - Activating Flow Test Mode opens the supply solenoid and allows water to pass to the manual supply valve. To activate Flow Test Mode, press and hold the Function key for one second (L3 will flash). To deactivate Flow Test Mode and allow the supply solenoid to close, press and hold the Function key again for one second.

CAUTION

The sump drain line must be clear and draining to a safe location before using Flow Test Mode.

CAUTION

Be aware of the water level in the sump tank at all times when using the Flow Test Mode.

Program Mode

Program Mode allows the user to view the Program Menu and edit the factory default settings. To access Program Mode and view the Program Menu press and hold the Enter key for three seconds. While viewing the Program Menu press the Up and Down keys to scroll through the Menu Options. To view the setting of the selected Menu Option, press the Enter key. To edit the setting, press the Up or Down key while viewing the setting. To save the setting and return to the Program Menu, press the Enter key. To return to the Program Menu without saving the change, wait 10 seconds. To exit Program Mode from the Program Menu, wait 10 seconds.

WARNING

Changing the default settings will significantly affect performance. Only change a setting after reading and understanding this entire manual.

WARNING

The Enter key must be pressed to save any changes made to a setting.

Dry Bulb Temperature

The dry bulb temperature is visible on the home screen. If a number is not visible, wait 15 seconds and use the Up and Down keys until a number is displayed.

Wet Bulb Temperature

To view the Wet Bulb Temperature, simultaneously press and hold the Up and Down keys.

Indicating Lights

Three indicating lights are located across the top of the display to indicate the status of the Water Wizard™.

Light Status				
Indicating Light	On	Off	Blinking Long on, short off	Blinking Short on, long off
L1	Call for cooling	No call for cooling	Call for cooling. Outdoor temperature lockout.	N/A
L2	Drain solenoid open	Drain solenoid closed	N/A	Supply solenoid open. Drain solenoid closed.
L3	Cooling on	Cooling off	Supply solenoid locked closed	Flow test mode active

Check Operation - VAV Units (optional)

NOTE

Blower Start-Up, Steps 1-5 should be performed before the blower is run.

NOTE

For maintenance issues associated with variable frequency drives, consult the drive's manual supplied with the unit. The drives are programmed at the factory and should not need any adjustment during installation and start-up. For kitchen applications, the drive may be located in the kitchen or in the unit.

Variable Volume Operation

The variable volume option is recommended when a building's exhaust volume may vary. This option enables the make-up air volume to track with the exhaust volume, providing only the amount of make-up air required. Control strategies include 2-speed VFD motors and modulating blowers. Before the unit is left in service, the variable volume control system should be tested.

2-Speed VFD Motor

A variable frequency drive (VFD) is used on a single speed motor to control air volumes. The VFD is factory-programmed for 2 speed operations. It can be switched to low or high speed from a remote control panel. Turn the fan speed switch on the remote control panel to each position and confirm that the fan speed adjusts accordingly.

Modulating

Potentiometer Control — a variable frequency drive is controlled by input from a remote speed selector (potentiometer). This unit allows easy manual adjustment of make-up air volumes. To test potentiometer operation, turn the potentiometer to the two extremes. With variable volume, make sure the fan goes to maximum and minimum speed.

When the potentiometer is at 0, the fan speed will be at its minimum. When the potentiometer is at 100, the fan will be at its maximum speed.

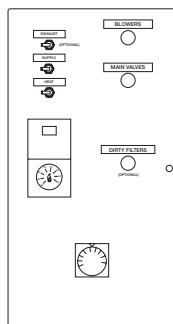

Potentiometer Control

Building Pressure Control — a variable frequency drive is controlled according to input from a pressure sensing device.

Turn both knobs to the upper most pressure setting. You may have to remove the outdoor pressure tap tubing. VAV systems should go to maximum speed. Set both knobs at the lowest setting and the VAV systems should go to minimum speed.

Reset the correct pressure limits before starting the unit.

This picture depicts a typical photohelic setting. Typical settings are 0.0 in. wg for the lower pressure setting and 0.10 in. wg for the upper pressure setting. The needle indicates a negative building pressure. During correct operation, the indicating needle will remain between or near the setting needles.

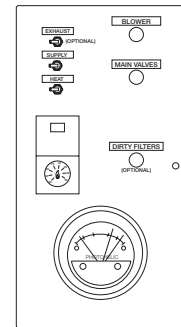

Building Pressure Control

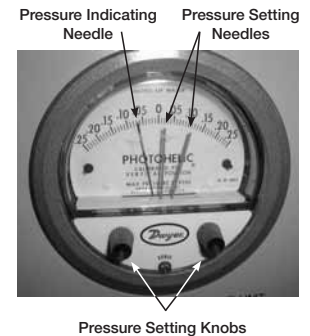

Photohelic Gauge

External Signal — a variable frequency drive is controlled according to input from an external 2-10 VDC or 4-20 mA signal (by others).

A 2 VDC or 4 mA signal will send the blower to low speed. The blower will go to maximum speed with a 10 VDC or 20 mA signal.

Variable Kitchen Control — A variable frequency drive is controlled by input from a remote speed control. This unit allows automatic adjustment of make-up air volumes based on varying cooking loads.

Check Operation - Recirculating Units (optional)

NOTE

Blower Start-Up, steps 1-5 should be performed before the blower is run.

Recirculation Operation

The recirculation operation option is recommended when the ventilation equipment provides the primary source of heating for the space. Recirculation can vary from 100% return air to 100% outside air. Control strategies include 2-position and modulating dampers.

Before the unit is left in service, the recirculation control system should be tested.

2-Position Damper

A 2-position spring return actuator is used to control the return air amounts. The damper moves from open to closed. If power is cut to the unit, the outdoor air damper will fail to close.

Turn the recirculating switch on the remote control panel to each position and confirm that the return air damper adjusts accordingly. The damper actuator may take a few minutes to open or close.

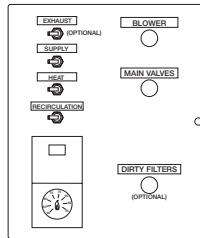

2-Position Damper Control

Modulating

Potentiometer Control - a modulating spring return actuator is used to control the return air amounts. The return air damper modulates from fully open to fully closed based on a signal from a remote potentiometer.

To test potentiometer operation, turn the potentiometer to the two extremes. Confirm that the return air damper fully opens and fully closes. When the potentiometer is at 0, the return air damper will open. When the potentiometer is at 100, the return air damper will close. The damper actuator may take a few minutes to open or close.

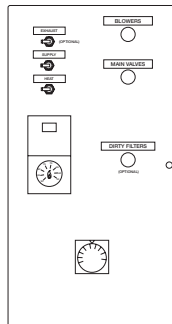

Potentiometer Control

Building Pressure Control - a modulating spring return actuator is used to control the return air amounts. The return air damper modulates from fully open to fully closed based on a signal from a remote pressure sensing device.

Turn both knobs to the upper most pressure setting. You may have to remove the outdoor pressure tap tubing. The return air damper should close.

Set both knobs at the lowest setting and the damper should open. It may take one to two minutes for the damper to reach the desired position.

Reset the correct pressure limits before starting the unit.

This picture shows a typical photohelic setting. Typical settings are 0.0 in. wg for the lower and 0.10 in. wg for the upper pressure setting. The needle in this photo indicates a negative building pressure. During correct operation, the indicating needle will remain between or near the setting needles.

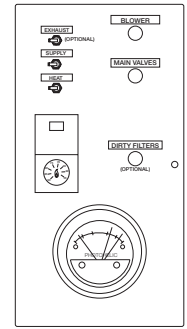

Building Pressure Control

Pressure Indicating Needle Pressure Setting Needles



Pressure Setting Knobs

Photohelic Gauge

External Signal - a modulating spring return actuator is used to control the return air amounts. Return air damper modulates from fully open to fully closed based on an external 2-10 VDC or 4-20 mA signal (by others).

The return air damper will close with a 10 VDC or 20 mA signal. The return air damper should open with a 2 VDC or 4mA signal. The damper actuator may take a few minutes to open or close.

Sequence of Operation

2:1 Staged Sequence

1. Exhaust Fan Contact (S1) Manually Closed (optional)

- Power passes through N.C. contact on exhaust fan overload (ST2 OL), which is closed if exhaust fan (M2) has not overloaded
- Power passes to exhaust fan starter (ST2)
- N.O. contact on exhaust fan starter (ST2) is energized and closed

- Power passes to and energizes exhaust fan (M2)

2. Supply Fan Contact (S2) Manually Closed

- Power passes through N.C. field-supplied fire contact (FSC)
- Power passes through optional N.O. contact on exhaust fan starter (ST2), which is closed when the optional exhaust starter (ST2) is activated
- Power passes through N.C. contact on supply starter overload (ST1 OL), which is closed if the supply fan has not overloaded
- Power passes through N.C. contact on optional freeze protection timer (RT4), which is closed if the temperature has remained above the set point
- Power passes to and energizes optional inlet damper (D1), which opens
- Power passes through optional damper limit switch (DL1), which is energized and closed if the optional inlet damper is open. It may take several minutes for the damper to fully open and for the damper limit switch to close
- Power passes to and energizes fan relay (RF)
- Power passes through N.O. contact on fan relay (RF), which is closed once the fan relay (RF) is activated
- Power passes to and energizes starter relay (ST1)
- N.O. contact on supply fan starter (ST1) is energized and closed
- Supply fan (M1) starts

3. Heat Contact (S4) Manually Closed

- Power passes through N.O. fan relay (RF), which is energized and closed if the supply fan (M1) is on
- Power passes through N.C. contact on optional inlet air sensor (TS4), which is closed if inlet air temperature is below the set point
- Power passes to and energizes the heat relay (RH)
- N.O. contact on heat relay (RH) closes
- 24 VAC is supplied to stage controller (SC1)
- If the discharge temperature is less than the set point on the discharge air sensor (TS2) and the high temperature limit control (HLC1) has not been tripped, the N.O. contact for furnace stage controller will close
- Power will be supplied to the ignition controller (IC1), which will begin its sequence of operation

4. Ignition Controller (IC1) Sequence of Operation

- The N.O. contact on air proving switch (PS2) is open
- The ignition controller (IC1) energizes the combustion blower relay (CR)
- N.O. contact on combustion blower relay (CR) closes
- Power passes to and energizes the combustion blower (CM)
- The N.O. contact on air proving switch (PS2) closes
- The ignition controller (IC1) begins a 15 second pre-purge
- The high fire relay (RT3) is energized and the N.O. contact on high fire relay (RT3) closes
- The main gas valve (MV) fully opens (100%)
- Igniter begins sparking
- 10 second trial for ignition begins
- The furnace will light at high fire (100%)
- When the flame is detected, the igniter stops sparking
- The furnace will remain at high fire (100%) for at least 10 seconds
- High fire contact (RT3) will open
- Furnace stages to maintain the discharge air temperature set point (SC1)

5. High Fire – Low Fire Sequence of Operation

- The furnace lights at high fire (100%) and remains at high fire for 10 seconds
- If the discharge temperature is above the discharge air sensor (TS2) set point, the N.O. furnace stage 2 controller contact (SC2), will open and the furnace will go to low fire (50%)
- If the furnace is at low fire (50%) and the discharge temperature is above the discharge air sensor (TS2) set point, the furnace stage 1 contact (SC1) will open and the furnace will shut down
- If the furnace is at low fire (50%) and the discharge temperature is below the discharge air sensor (TS2) set point, the furnace stage 2 contact (SC2) will close and the furnace will go to high fire

6. Optional Evaporative Cooling Contact (S4) Closed*

- N.O. contact on fan relay (RF) is energized and closed
- Power passes through N.O. contact on optional inlet air sensor (TS4), which is energized and closed if the inlet air temperature is above the set point
- Power passes to and energizes cool relay (RC)
- N.O. contact on cool relay (RC) is energized and closed
- Power passes to evaporative cooling pump (P1)

*If DX or chilled water coils are used rather than an evaporative cooler, the cooling sequence of operation will depend on the coil controls. Cooling coil controls are supplied by others.

Sequence of Operation

2:1 Modulation Sequence

1. Exhaust Fan Contact (S1) Manually Closed (optional)

- Power passes through N.C. contact on exhaust fan overload (ST2 OL), which is closed if exhaust fan (M2) has not overloaded
- Power passes to exhaust fan starter (ST2)
- N.O. contact on exhaust fan starter (ST2) is energized and closed
- Power passes to and energizes exhaust fan (M2)

2. Supply Fan Contact (S2) Manually Closed

- Power passes through N.C. field-supplied fire contact (FSC)
- Power passes through optional N.O. contact on exhaust fan starter (ST2), which is closed when the optional exhaust starter (ST2) is activated
- Power passes through N.C. contact on supply starter overload (ST1 OL), which is closed if the supply fan has not overloaded
- Power passes through N.C. contact on optional freeze protection timer (RT4), which is closed if the temperature has remained above the set point
- Power passes to and energizes optional inlet damper (D1), which opens
- Power passes through optional damper limit switch (DL1), which is energized and closed if the optional inlet damper is open. It may take several minutes for the damper to fully open and for the damper limit switch to close
- Power passes to and energizes fan relay (RF)
- Power passes through N.O. contact on fan relay (RF), which is closed once the fan relay (RF) is activated
- Power passes to and energizes starter relay (ST1)
- N.O. contact on supply fan starter (ST1) is energized and closed
- Supply fan (M1) starts

3. Heat Contact (S4) Manually Closed

- Power passes through N.O. contact on fan relay (RF), which is energized and closed if the supply fan (M1) is on
- Power passes through the N.C. contact on optional inlet air sensor (TS4), which is closed if inlet air temperature is below set point
- Power passes to and energizes the heat relay (RH)
- Power passes to N.C. contact on high temperature limit control (HLC1), which remains closed if it has not been tripped
- N.O. contact on heat relay (RH) closes
- 24 VAC is supplied to ignition controller (IC1) and amplifier (AMP)
- If the discharge air sensor (TS2) reading is less than the temperature selector (TS3) setting, the

amplifier (AMP) sends a call for heating to the ignition controller (IC1)

4. Ignition Controller (IC1) Sequence of Operation

- The N.O. contact on air proving switch (PS2) is open
- The ignition controller (IC1) energizes the combustion blower relay (CR)
- N.O. contact on combustion blower relay (CR) closes
- Power passes to and energizes the combustion blower (CM)
- The N.O. contact on air proving switch (PS2) closes
- The ignition controller (IC1) begins a 15 second pre-purge
- The high fire relay (RT3) is energized and the N.O. contact on high fire relay (RT3) closes
- The main gas valve (MV) fully opens (100%) and the modulating gas valve (MOD) opens to high fire
- Igniter begins sparking
- 10 second trial for ignition begins
- The furnace will light at high fire (100%)
- When the flame is detected, the igniter stops sparking
- The furnace will remain at high fire (100%) for at least 10 seconds
- High fire contact (RT3) will open
- Furnace modulates to maintain the temperature selector (TS3) set point

5. High Fire – Low Fire Sequence of Operation

- The furnace lights at and remains at high fire (100%) for 10 seconds
- If the discharge temperature sensor (TS2) reading is above the temperature selector (TS3) set point, and furnace is not at low fire, the amplifier will adjust the modulating gas valve (MOD) down until the discharge temperature sensor (TS2) reading equals the temperature selector (TS3) setting
- If the discharge temperature sensor (TS2) reading is below the temperature selector (TS3) set point, and the furnace is not at high fire, the amplifier will adjust the modulating gas valve (MOD) up until the discharge temperature sensor (TS2) reading equals the temperature selector (TS3) setting
- If the furnace is at low fire and the discharge temperature sensor (TS2) reading is above the temperature selector (TS3) set point, the amplifier will end the call for heat and the ignition controller (IC1) will shut down the furnace

6. Optional Evaporative Cooling Contact (S4) Closed*

- N.O. contact on fan relay (RF) is energized and closed
- Power passes through N.O. contact on optional inlet air sensor (TS4), which is energized and closed if the inlet air temperature is above the set point
- Power passes to and energizes cool relay (RC)

Sequence of Operation

2:1 Modulation Sequence, *continued*

- N.O. contact on cool relay (RC) is energized and closed
 - Power passes to evaporative cooling pump (P1)
- *If DX or chilled water coils are used rather than an evaporative cooler, the cooling sequence of operation will depend on the coil controls. Cooling coil controls are supplied by others.

Operation

4:1 Modulation and 8:1 Staged Controller

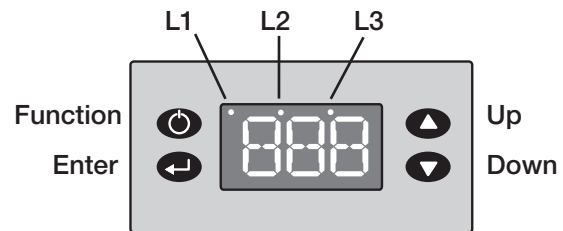

Water Wizard™ User Interface
Key Function Description

Program Mode

Program Mode allows the user to view the Program Menu and edit the factory default settings. To access Program Mode and view the Setpoints Menu, press and hold the Function key for three seconds. While viewing the Setpoints Menu, press the Up or Down key to scroll through the menu options. To view the setting of the selected menu option, press the Enter key. To edit the setting, press the Up or Down key while viewing the setting. To save the setting and return to the Setpoints Menu press the Enter key. To return to the Setpoints Menu without saving the change, wait 15 seconds. To exit Program Mode from the Setpoints Menu, wait 15 seconds.

WARNING

Changing the default settings will significantly affect performance. Only change a setting after reading and understanding this entire manual.

NOTE

The Enter key must be pressed to save any changes made to a setting.

Inlet Air Sensor (iAS)

The inlet air sensor monitors the temperature of the inlet air. If the inlet air is above the sensor's set point, the inlet air sensor shuts off the furnace and continues to supply the warm outside air. The inlet air sensor is preset to the factory recommended 65°F for 8:1 and 60°F for 4:1.

Discharge Air Temperature (dtS)

The discharge air temperature setting is the temperature that the unit will discharge. The discharge air temperature is preset to the factory recommended 70°F. The actual discharge air temperature is the default display.

Outside Air Temperature (OAt)

To temporarily display the outside air temperature, use the Up or Down key until the display reads "OAt," then press the Enter key.

Program Revision Number

To access the program revision number from the default display, press the Up or Down key until the display reads *F##*, *J##* or *I##*. The two numbers following the letter indicate the revision number. For example, *F12* indicates program *F*, revision twelve.

Optional Room Override (ROt)

When the room override function is triggered, the discharge air temperature (70°F default) is temporarily changed to the room override setting (90°F default). When the room override function is released the discharge air temperature returns to the default temperature.

Indicating Lights

Three indicating lights are located across the top of the display to indicate the status of the furnace.

4:1 Electronic Modulation			
Light	On	Off	Blinking
L1	Call for Heat	No call for heat	High fire
L2	Call for heat sent to ignition controller	No call for heat sent to ignition controller	High fire
L3	Combustion fan high speed	Combustion fan low speed	High fire
8:1 Staged Control (Single Furnace Units)			
Light	On	Off	Blinking
L1	Call for heat	No call for heat	N/A
L2	n/a	n/a	High fire
L3	Burner interlock	n/a	n/a
8:1 Staged Control (Multi Furnace Units)			
Light	On	Off	Blinking
L1	n/a	n/a	n/a
L2	n/a	n/a	Alarm
L3	Program Mode	n/a	Saving new setting

Sequence of Operation

4:1 Electronic Modulation

1. Exhaust Fan Contact (S1) Manually Closed (optional)

- Power passes through N.C. contact on exhaust fan overload (ST2 OL), which is closed if exhaust fan (M2) has not overloaded
- Power passes to exhaust fan starter (ST2)
- N.O. contact on exhaust fan starter (ST2) is energized and closed
- Power passes to and energizes exhaust fan (M2)

2. Supply Fan Contact (S2) Manually Closed

- Power passes through N.C. field-supplied fire contact (FSC)
- Power passes through optional N.O. contact on exhaust fan starter (ST2), which is closed when the optional exhaust starter (ST2) is activated
- Power passes through N.C. contact on supply starter overload (ST1 OL), which is closed if the supply fan has not overloaded
- Power passes through N.C. contact on optional freeze protection timer (RT4), which is closed if the temperature has remained above the set point
- Power passes to and energizes optional inlet damper (D1), which opens
- Power passes through optional damper limit switch (DL1), which is energized and closed if the optional inlet damper is open. It may take several minutes for the damper to fully open and for the damper limit switch to close
- Power passes to and energizes fan relay (RF)
- Power passes through N.O. contact on fan relay (RF), which is closed once the fan relay (RF) is activated
- Power passes to and energizes starter relay (ST1)
- N.O. contact on supply fan starter (ST1) is energized and closed
- Supply fan (M1) starts

3. Heat Contact (S4) Manually Closed

- Power passes through N.O. contact on fan relay (RF), which is energized and closed if the supply fan (M1) is on
- Power passes to and energizes the heat relay (RH)
- N.O. contact on heat relay (RH) closes
- Power passes to N.C. contact on high temperature limit control (HLC1), which remains closed if it has not been tripped
- 24 VAC is supplied to ignition controller (IC1)
- The modulating controller (SC1) compares the inlet air temperature to the inlet air set point (iAS, FX Program Menu). If the inlet air temperature is below the set point, the modulating controller (SC1) closes N.O. contact (FUR 1) and sends a call for heat to the ignition controller (IC1)

Sequence of Operation

4:1 Electronic Modulation, *continued*

4. Ignition Controller (IC1) Sequence of Operation

- The N.O. contact on air proving switch (PS2) is open
- The ignition controller (IC1) energizes the induction relay (IR)
- N.O. contact on induction relay (IR) closes
- Power passes to and energizes the combustion blower (CM), sending it to high speed
- The N.O. contact on air proving switch (PS2) and high pressure switch (PS5) closes
- The ignition controller (IC1) begins a 15 second pre-purge
- The main gas valve (MV) fully opens (100%) and the modulating gas valve (MOD) opens to high fire
- Igniter begins sparking
- 10 second trial for ignition begins
- The furnace will light at high fire (100%)
- When the flame is detected, the igniter stops sparking
- The furnace will remain at high fire (100%) for 30 seconds
- The modulation controller (SC1) will adjust the modulating gas valve (MOD) and the combustion blower (CM) as needed between low and high fire
- The modulating controller (SC1) will monitor the high pressure switch (PS5) and run the furnace at low fire if the high pressure switch is not satisfied

5. High Fire – Low Fire Sequence of Operation

- The furnace lights at and remains at high fire (100%) for 30 seconds
- If the discharge temperature sensor (TS2) reading is above the discharge temperature setting (dtS, FX Program Menu), and the furnace is not at low fire, the modulating controller (SC1) will adjust the modulating gas valve (MOD) down until the discharge temperature sensor (TS2) reading equals the discharge temperature setting (dtS, FX Program Menu)
- If the discharge temperature sensor (TS2) reading is below the discharge temperature setting (dtS, FX Program Menu), and the furnace is not at high fire, the modulating controller (SC1) will adjust the modulating gas valve (MOD) up until the discharge temperature sensor (TS2) reading equals the discharge temperature setting (dtS, FX Program Menu)

6. Optional Evaporative Cooling Contact (S4) Closed*

- N.O. contact on fan relay (RF) is energized and closed
- Power passes through N.O. contact on inlet air sensor (TS4), which is energized and closed if the inlet air temperature is above the set point

- Power passes to and energizes cool relay (RC)
 - N.O. contact on cool relay (RC) is energized and closed
 - Power passes to evaporative cooling pump (P1)
- *If DX or chilled water coils are used rather than an evaporative cooler, the cooling sequence of operation will depend on the coil controls. Cooling coil controls are supplied by others.

Sequence of Operation

8:1 Staged Control

1. Exhaust Fan Contact (S1) Manually Closed (optional)

- Power passes through N.C. contact on exhaust fan overload (ST2 OL), which is closed if exhaust fan (M2) has not overloaded
- Power passes to exhaust fan starter (ST2)
- N.O. contact on exhaust fan starter (ST2) is energized and closed

2. Supply Fan Contact (S2) Manually Closed

- Power passes through N.C. field-supplied fire contact (FSC)
- Power passes through optional N.O. contact on exhaust fan starter (ST2), which is closed when the optional exhaust starter (ST2) is activated
- Power passes through N.C. contact on supply starter overload (ST1 OL), which is closed if the supply fan has not overloaded
- Power passes through N.C. contact on optional freeze protection timer (RT4), which is closed if the temperature has remained above the set point
- Power passes to and energizes optional inlet damper (D1), which opens
- Power passes through optional damper limit switch (DL1), which is energized and closed if the optional inlet damper is open. It may take several minutes for the damper to fully open and for the damper limit switch to close
- Power passes to and energizes fan relay (RF)
- Power passes through N.O. contact on fan relay (RF), which is closed once the fan relay (RF) is activated
- Power passes to and energizes starter relay (ST1)
- N.O. contact on supply fan starter (ST1) is energized and closed
- Supply fan (M1) starts

3. Heat Contact (S4) Manually Closed

- Power passes through N.O. contact on fan relay (RF), which is energized and closed if the supply fan (M1) is on
- Power passes to and energizes the heat relay (RH)
- N.O. contact on heat relay (RH) closes
- The stage controller (SC1) compares the inlet air temperature to the inlet air set point (IAS, FX Program Menu). If the inlet air temperature is below the discharge air setting (dtS, FX Program Menu), the stage controller sends a call for heat to the ignition controller (IC1)

4. Ignition Controller (IC1) Sequence of Operation

- The N.O. contact on air proving switch (PS2) is open
- The stage controller (SC1) energizes the combustion blower relay (CR)

- N.O. contact on combustion blower relay (CR) closes
- Power passes to and energizes the combustion blower (CM)
- The N.O. contact on air proving switch (PS2) closes
- Power passes to and energizes air proving switch relay (R9)
- N.O. contacts on air proving switch (R9) closes
- The ignition controller (IC) completes a 30 second pre-purge
- The main gas valve (MV) fully opens (100%)
- Igniter begins sparking
- 10 second trial for ignition begins
- The furnace will light
- The stage controller (SC1) will choose which stage to light the furnace at based on the discharge air temperature setting (dtS, FX Program Menu) and the outside air temperature (TS1)
- When the flame is detected, the igniter stops sparking
- The furnace will remain at high fire (100%) for 20 seconds
- The stage controller (SC1) will stage the main gas valves (MV#) as needed between low fire, high fire and off
- If the furnace is at low fire and the discharge temperature sensor (TS2) reading remains above the discharge air temperature setting (dtS, FX Program Menu) for more than six minutes, the furnace will shut down

5. Staging Control Sequence of Operation

- If the discharge temperature (TS2) is below the discharge air temperature set point (dtS, FX Program Menu), the furnace will stage up
- If the discharge temperature (TS2) is above the discharge air temperature set point (dtS, FX Program Menu), the furnace will stage down
- If the discharge temperature (TS2) is above the discharge air temperature set point (dtS, FX Program Menu) and the furnace is at low fire, the furnace will shut off
- If the furnace is at high fire and the discharge air temperature setting (dtS, FX Program Menu) is not satisfied, the furnace will remain at high fire
- If the furnace is at low fire and the discharge air temperature setting (dtS, FX Program Menu) is satisfied, the furnace will shut off

6. Optional Evaporative Cooling Contact (S4) Closed*

- N.O. contact on fan relay (RF) is energized and closed
- Power passes through N.O. contact on optional inlet air sensor (TS4), which is energized and closed if the inlet air temperature is above the set point
- Power passes to and energizes cool relay (RC)

Sequence of Operation

8:1 Staged Control, *continued*

- N.O. contact on cool relay (RC) is energized and closed
- Power passes to evaporative cooling pump (P1)

*If DX or chilled water coils are used rather than an evaporative cooler, the cooling sequence of operation will depend on the coil controls. Cooling coil controls are supplied by others.

Operation and Errors - Ignition Controller

NOTE

The green LED light indicates NORMAL operation while the red LED light indicates an ERROR operation.

This controller is found only in the furnace control center. It has an LED indicator light on the top right of the controller that will flash GREEN for

NORMAL operation or RED for an ERROR. Some furnace configurations have two of these controllers.



The following are the green LED codes of operation:

GREEN LED Indications - NORMAL OPERATION	
Flash Code	Flash Code Indication
Steady on	Flame detected, main burner on
0.1 second on/off	Controller is sparking
0.5 second on/off	Purge or inter-purge time
0.5 second on/4.5 second off	Retry or recycle time

The following are the red LED codes of error:

RED LED Indications - ERROR OPERATION	
Flash Code	Flash Code Indication
Blinks 1 time	No flame in trial time error
Blinks 2 times	Flame sense circuit error
Blinks 3 times	Valve circuit error
Blinks 4 times	Flame loss error
Blinks 6 times	Airflow error
Blinks 7 times	Ground or internal error
Steady on	Line voltage/frequency error

Operation - Economizer

NOTE

Only models IG-HV and IGX-HV with options EC-1, 2, 3 or 4 use an economizer.

Option EC-1 (Outside Air Temperature Reference)

This option uses one dry bulb temperature sensor field-installed in the inlet of the unit. A second dry bulb temperature sensor is factory-installed in the discharge of the unit.

After a call for cooling, the outside air temperature is compared to the economizer set point. If the outside air temperature is above the economizer set point, the economizer sends the dampers to the minimum outside air position and calls for mechanical cooling. If the outside air temperature is between the economizer set point and 55°F, the economizer sends the dampers to the 100% outside air position. If the outside air is less than 55°F, the economizer modulates the dampers to achieve a 55°F mixed air temperature.

Option EC-2 (Outside Air Enthalpy Reference)

This option uses one enthalpy sensor field-installed in the inlet of the unit. A dry bulb temperature sensor is installed in the discharge of the unit.

After a call for cooling, the outside air enthalpy is compared to the field-adjustable enthalpy changeover set point. If the outside air enthalpy is less than the set point, the dampers will modulate to provide a 55°F mixed air temperature. If the outside air enthalpy is greater than the set point, the economizer sends the damper to the minimum outside air position and sends a call for mechanical cooling.

Option EC-3 (Differential Temperature Control)

This option uses one dry bulb temperature sensor field-installed in the inlet of the unit. A second dry bulb temperature sensor is field-installed in the return air duct. A third dry bulb temperature sensor is factory-installed in the discharge of the unit.

After a call for cooling the economizer compares the outdoor and return air temperatures. If the outdoor air temperature is greater than the return air dry bulb temperature, the economizer sends the dampers to the minimum outside air position and sends a call for mechanical cooling. If the outside air temperature is less than the return air temperature, the economizer will modulate the dampers to achieve a 55°F mixed air temperature. If the outside air temperature is less than the return air temperature, but a 55°F mixed air temperature cannot be achieved, the programmable room thermostat may call for mechanical cooling.

Option EC-4 (Differential Enthalpy Control)

This option uses one enthalpy sensor, field-installed in the inlet of the unit. A second enthalpy sensor is field-installed in the return air duct. A dry bulb temperature sensor is factory-installed in the discharge of the unit.

After a call for cooling the economizer compares the outdoor and return air enthalpies. If the outdoor air enthalpy is greater than the return air enthalpy, the economizer sends the dampers to the minimum outside air position and sends a call for mechanical cooling. If the outside enthalpy is less than the return air enthalpy, the economizer will modulate the dampers to achieve a 55°F mixed air temperature. If the outside enthalpy is less than the return air temperature, but a 55°F mixed air temperature cannot be achieved, the programmable room thermostat may call for mechanical cooling.

Troubleshooting

Blower Does Not Operate

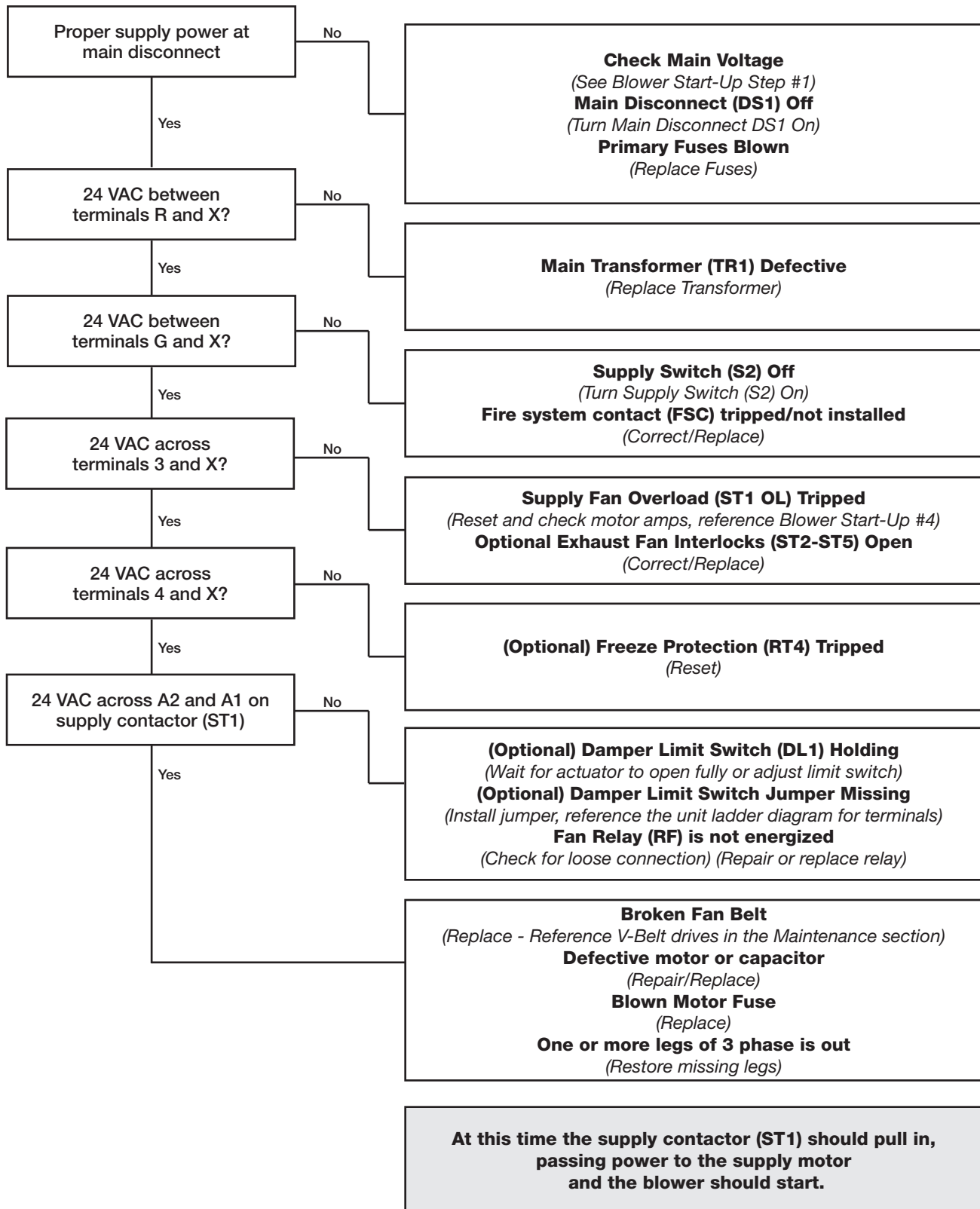

Troubleshooting

Motor Over Amps

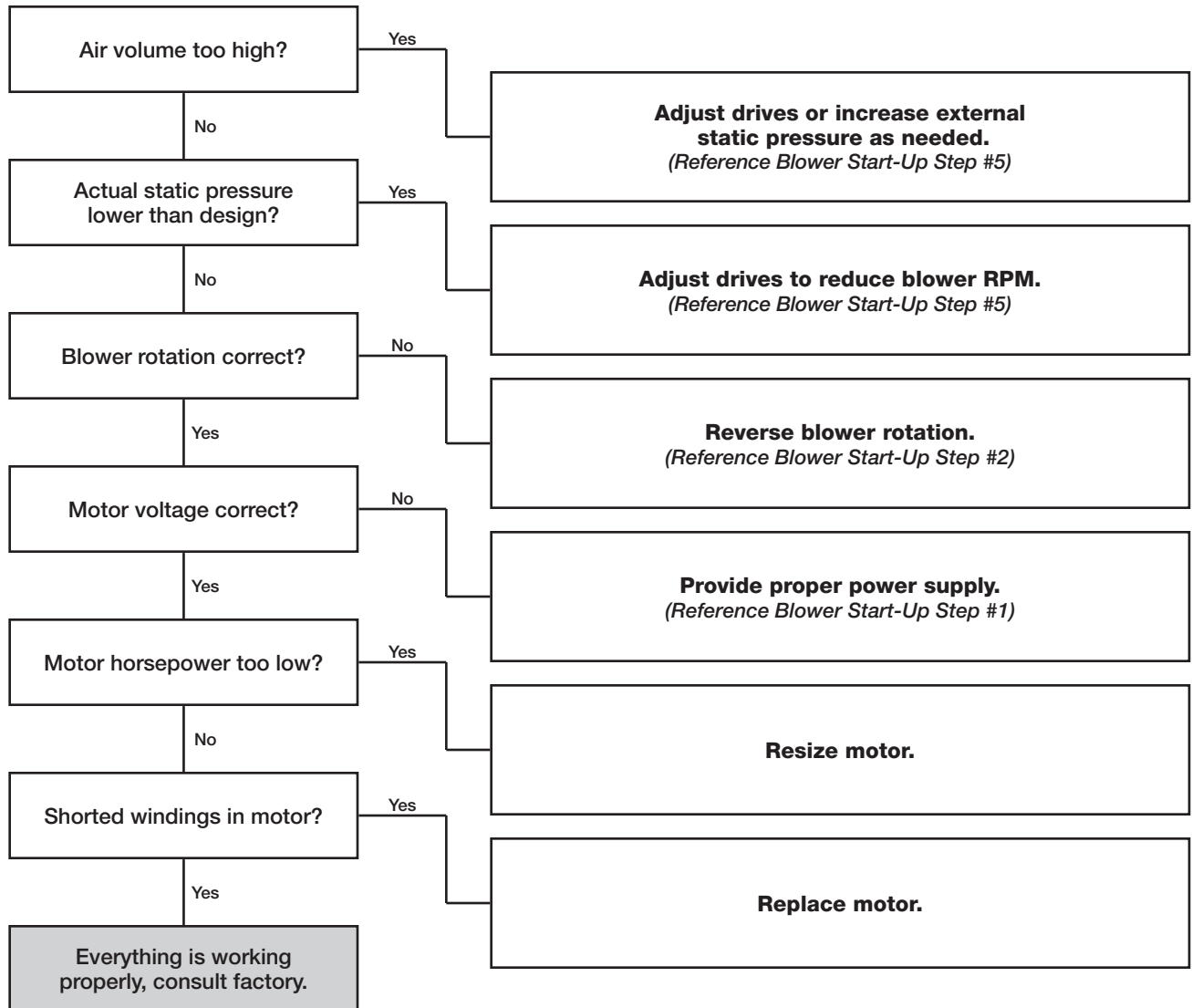

Troubleshooting

Insufficient Airflow

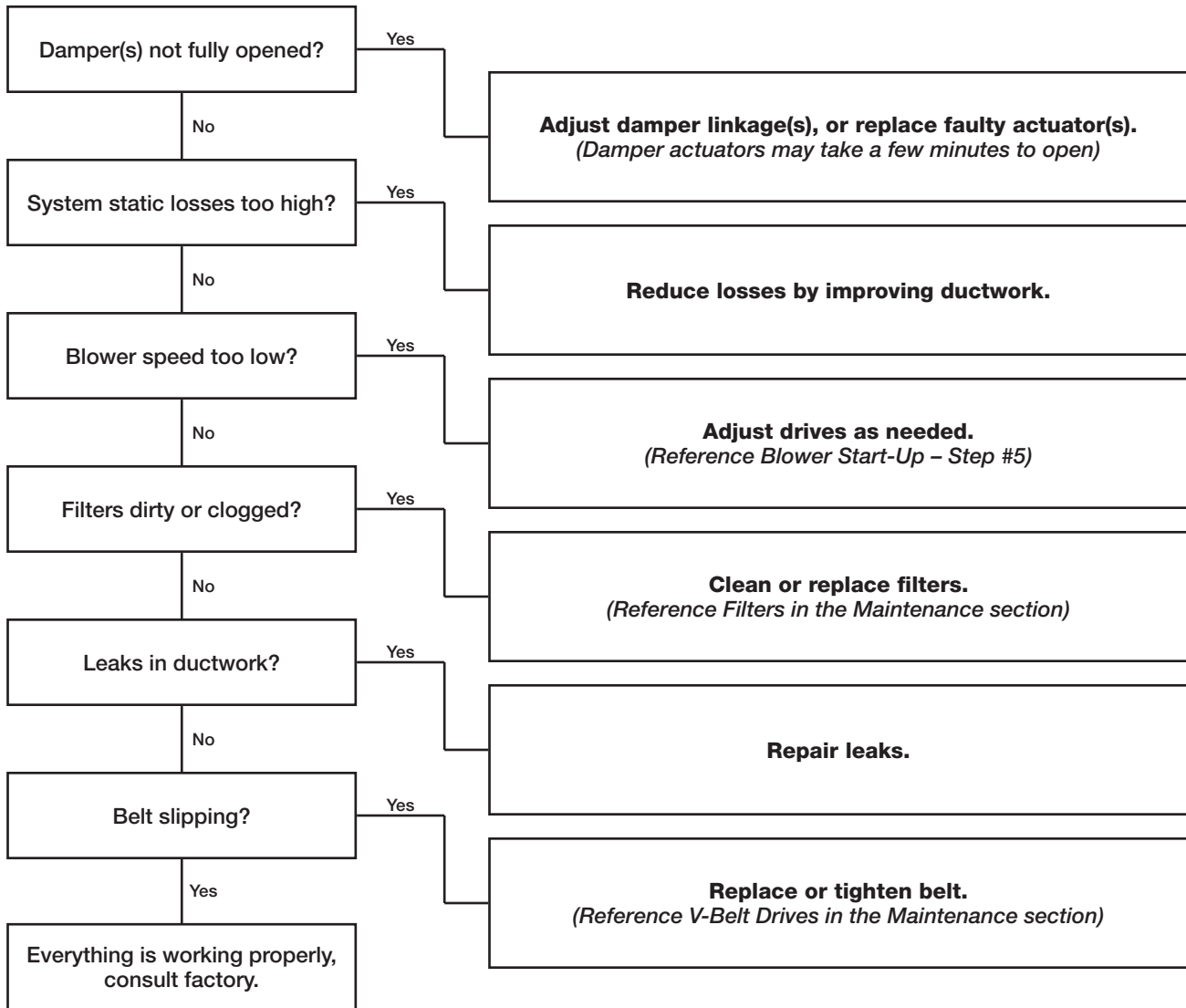

Too Much Airflow

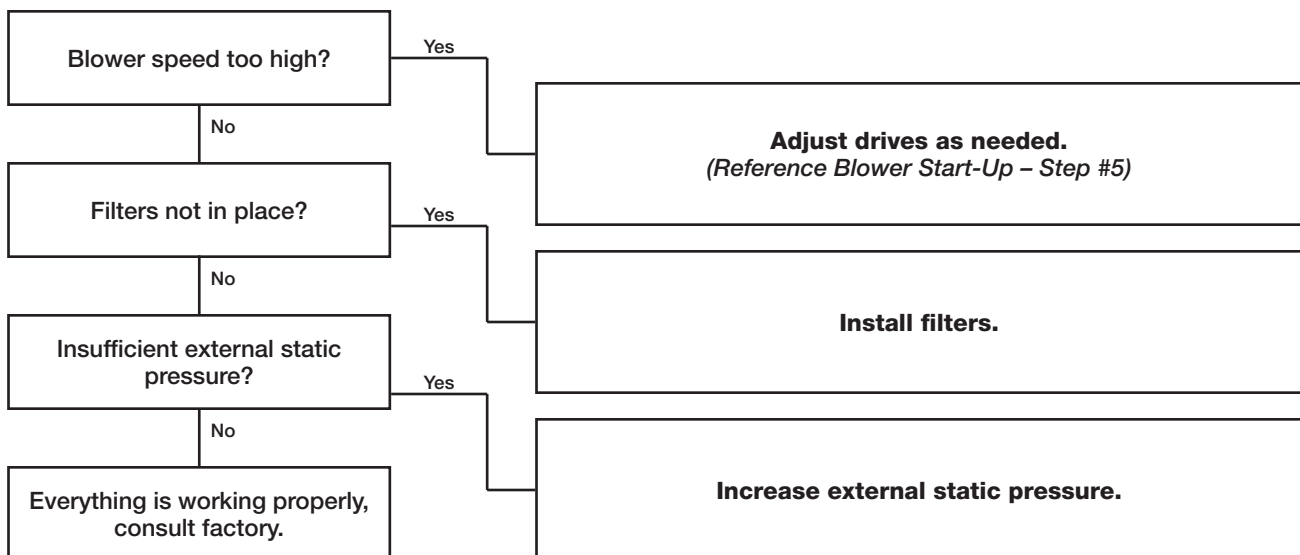

Troubleshooting

Excessive Noise or Vibration

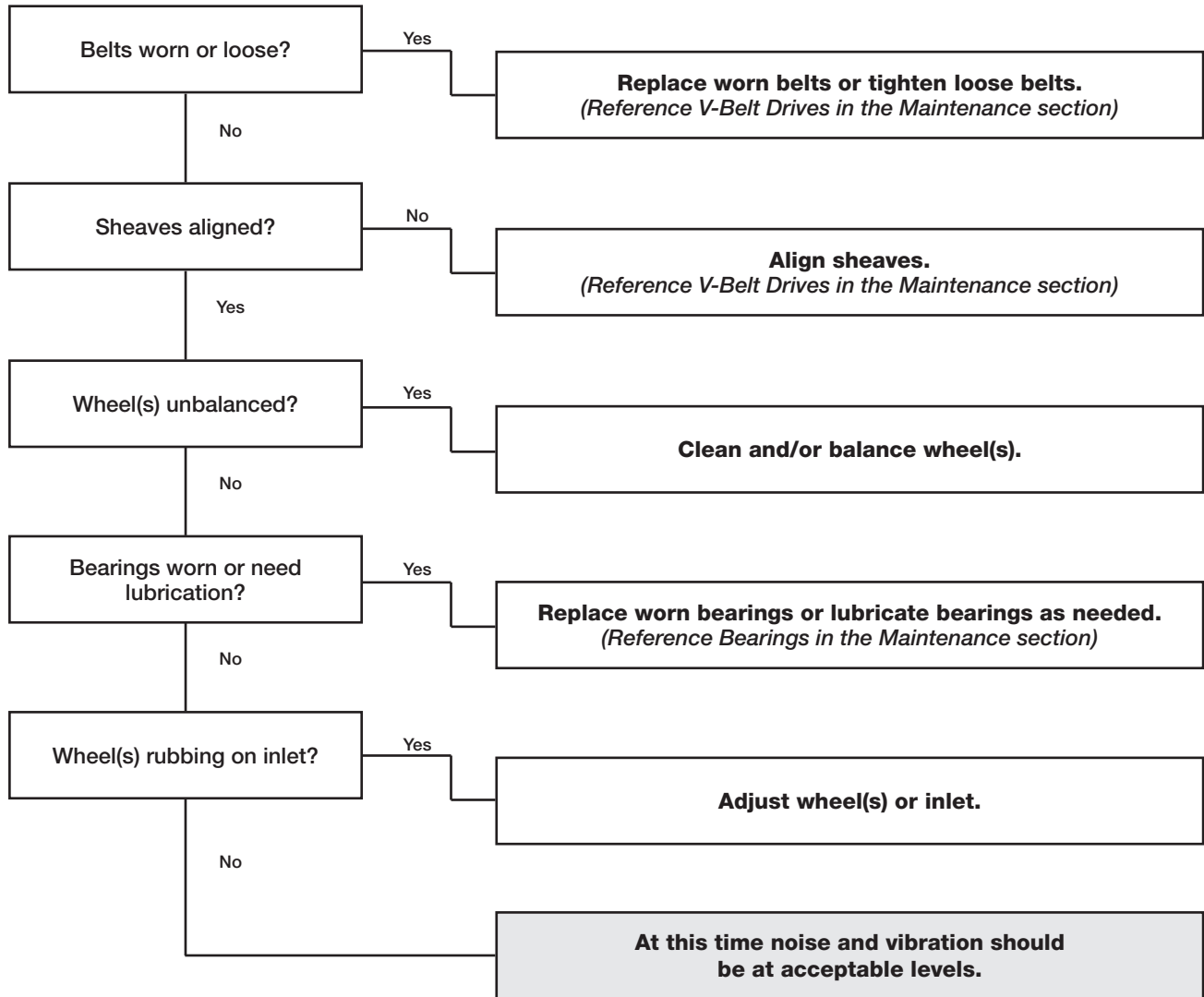

Troubleshooting

Single or 2:1 Stage Furnace Will Not Light

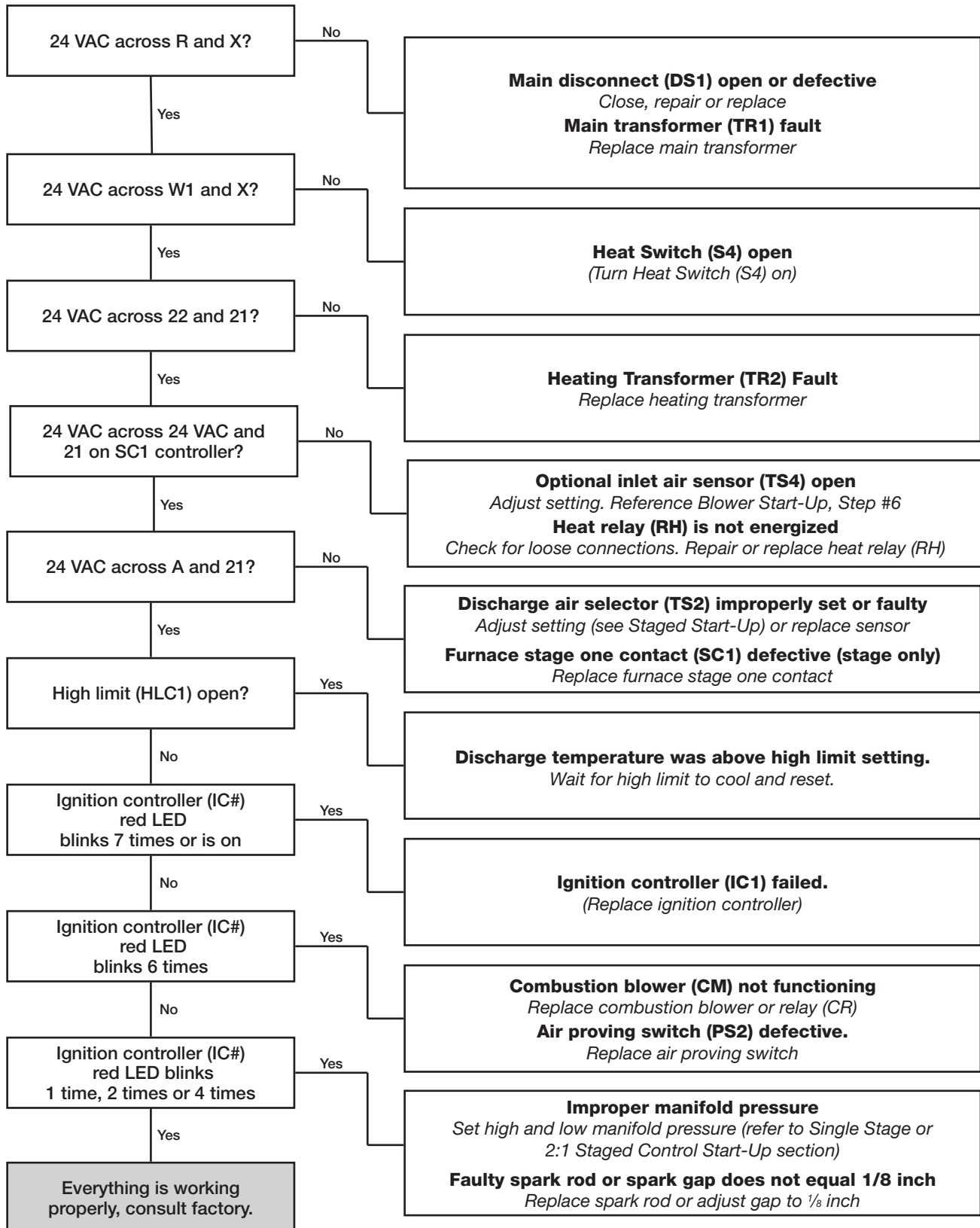

Troubleshooting

2:1 Modulating Furnace Will Not Light

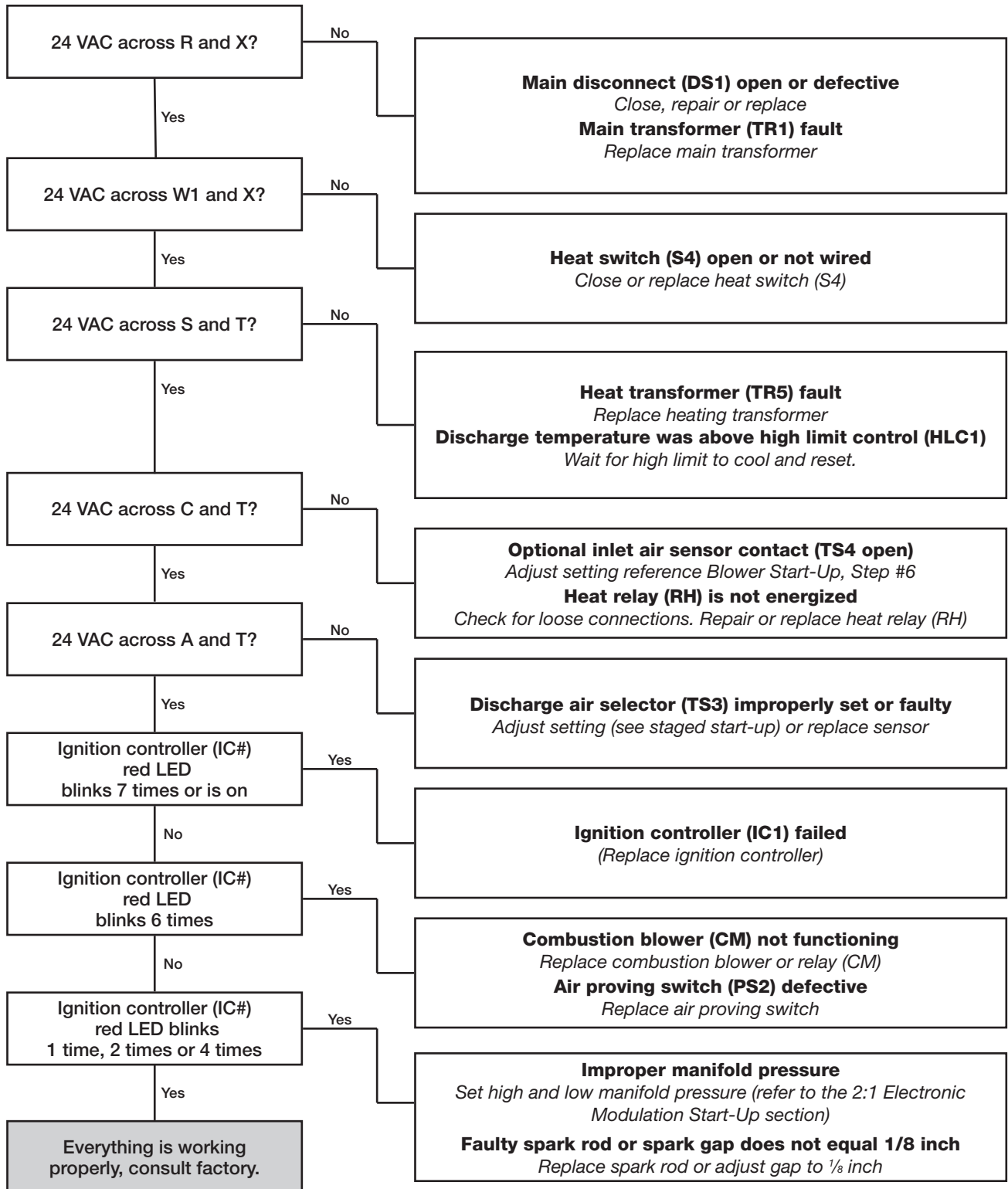

Troubleshooting

4:1 Modulating Furnace Will Not Light

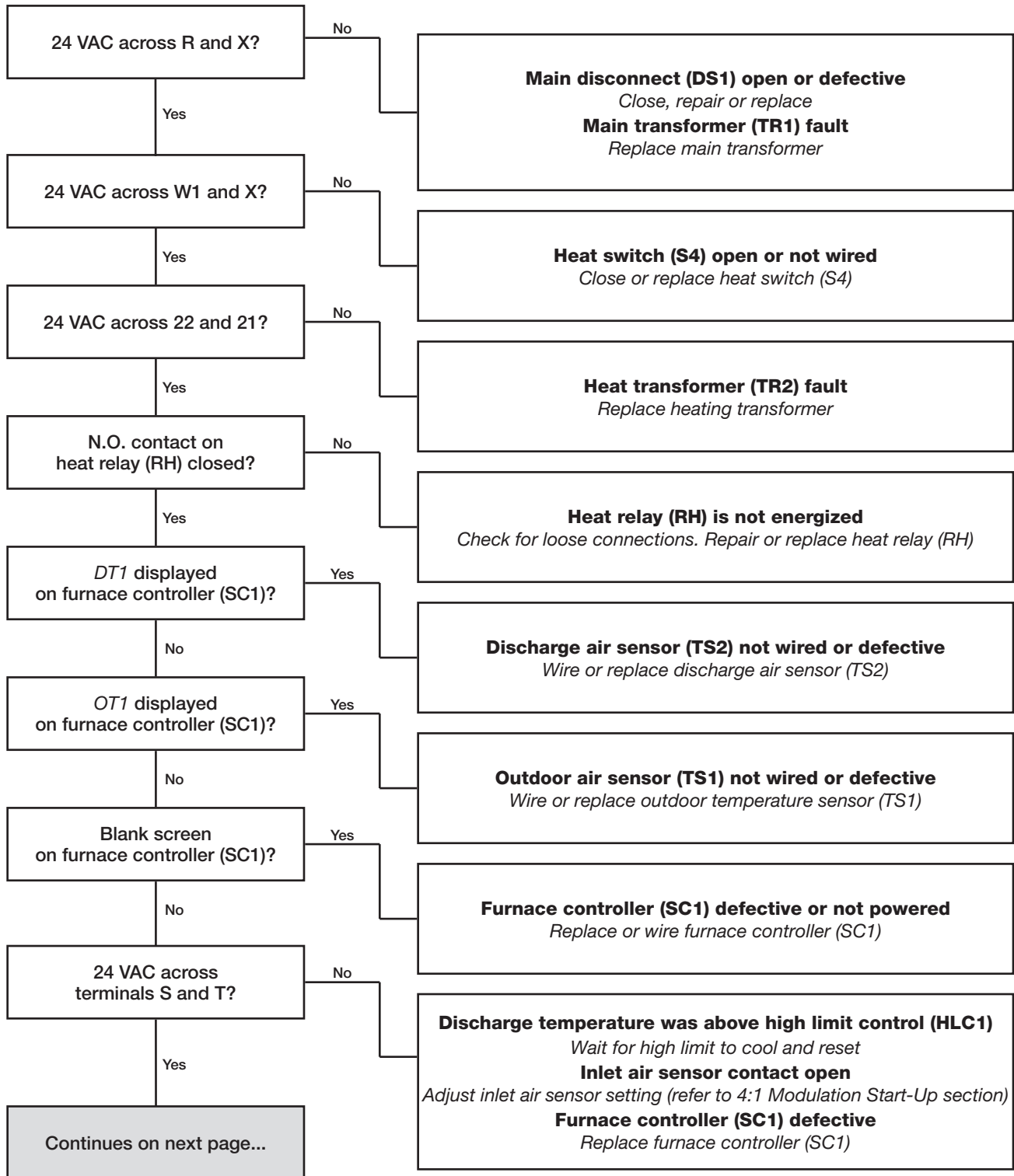

Troubleshooting

4:1 Modulating Furnace Will Not Light

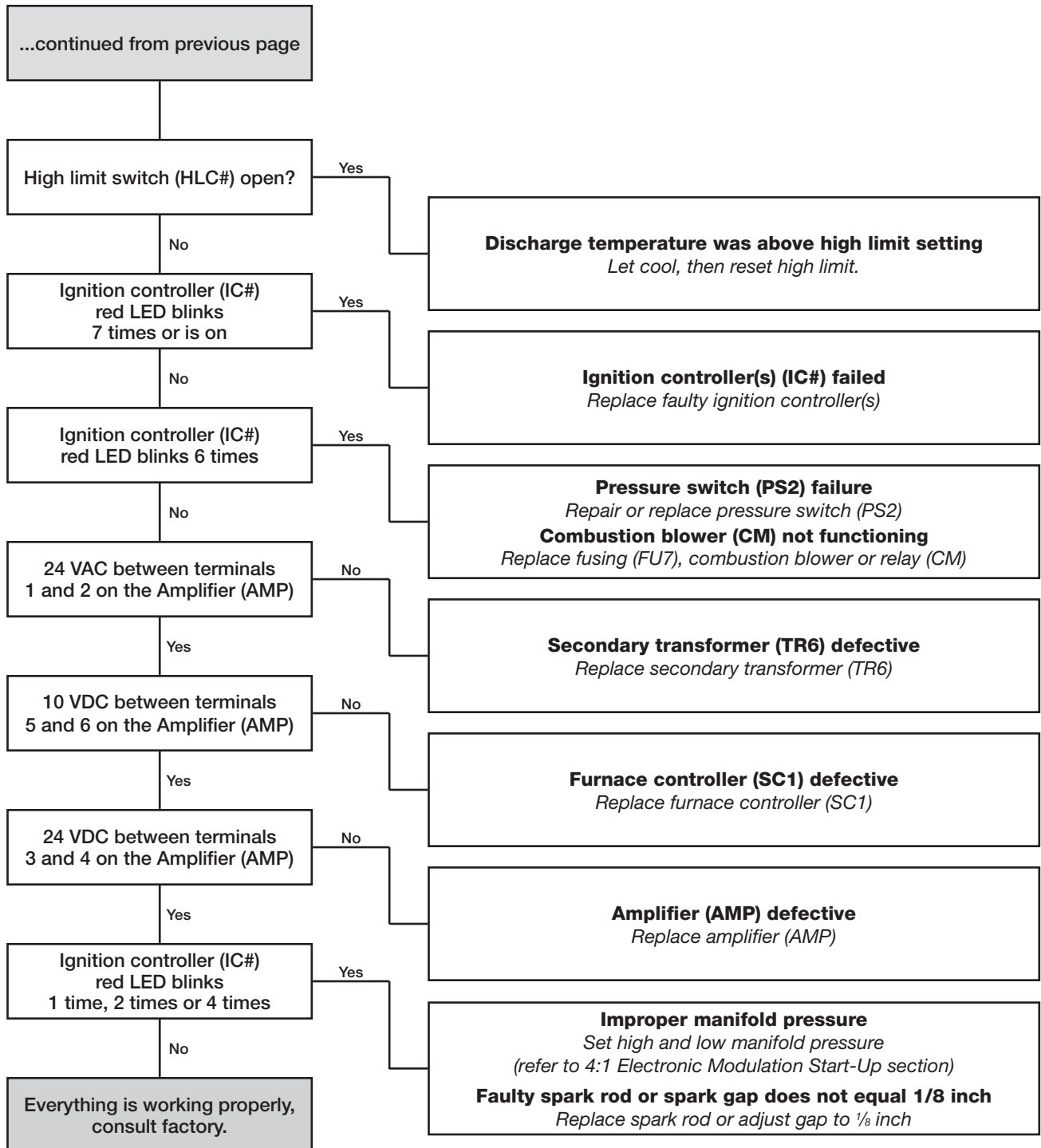

Troubleshooting

8:1 Staged Furnace Will Not Light

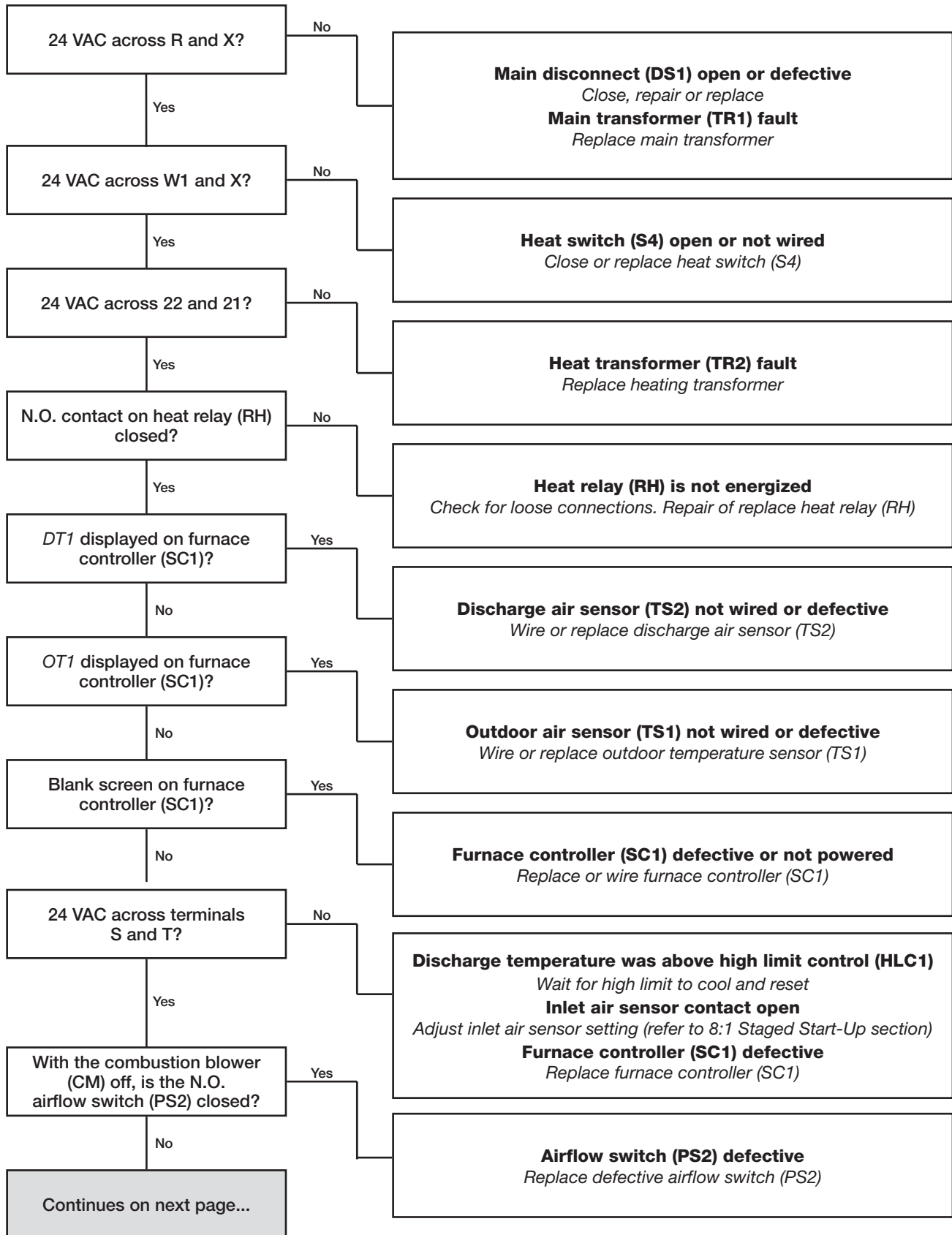

Troubleshooting

8:1 Staged Furnace Will Not Light

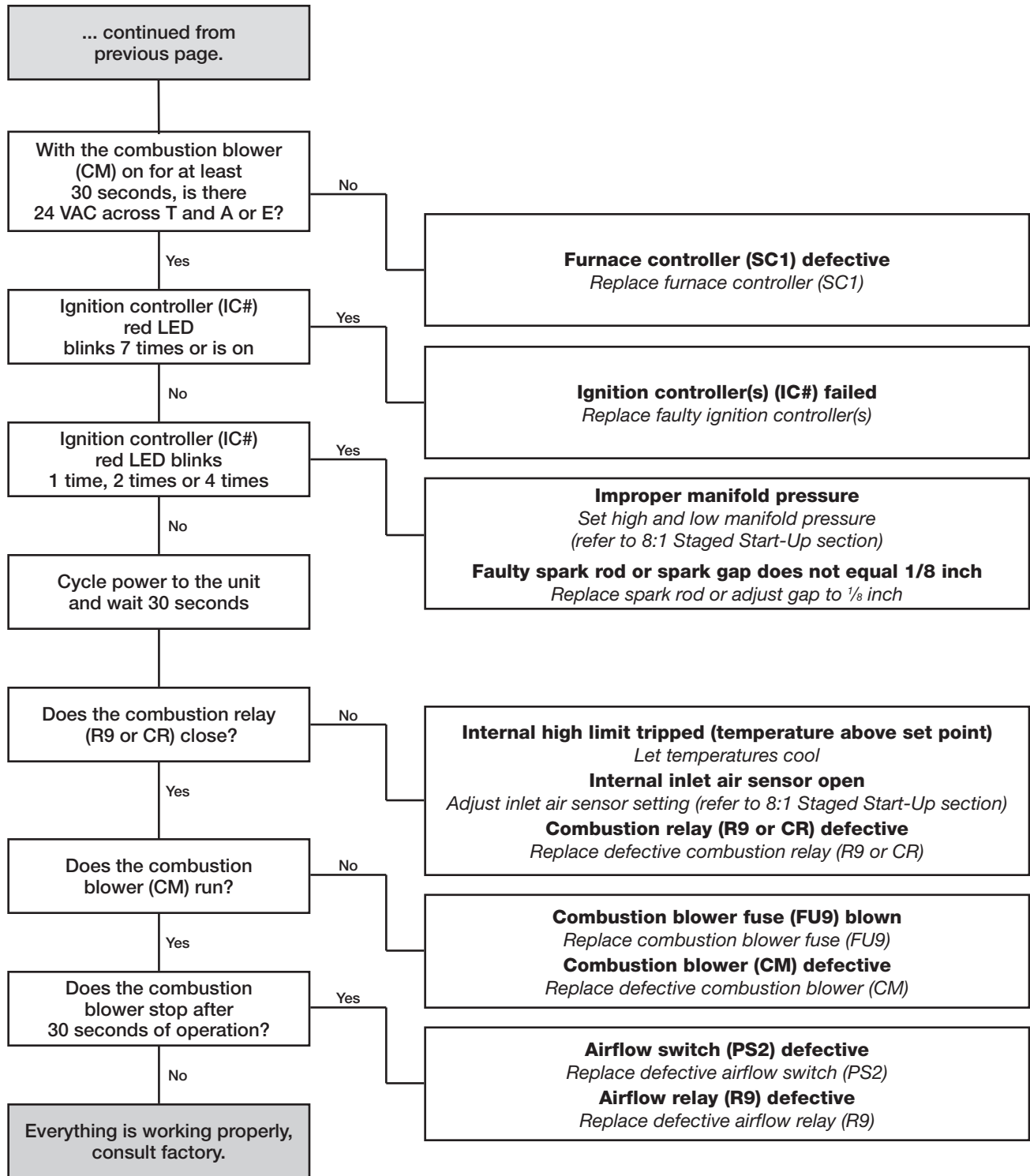

Troubleshooting

Evaporative Cooler does not Operate (Recirculating pump)

Supply fan must be on for cooler to operate

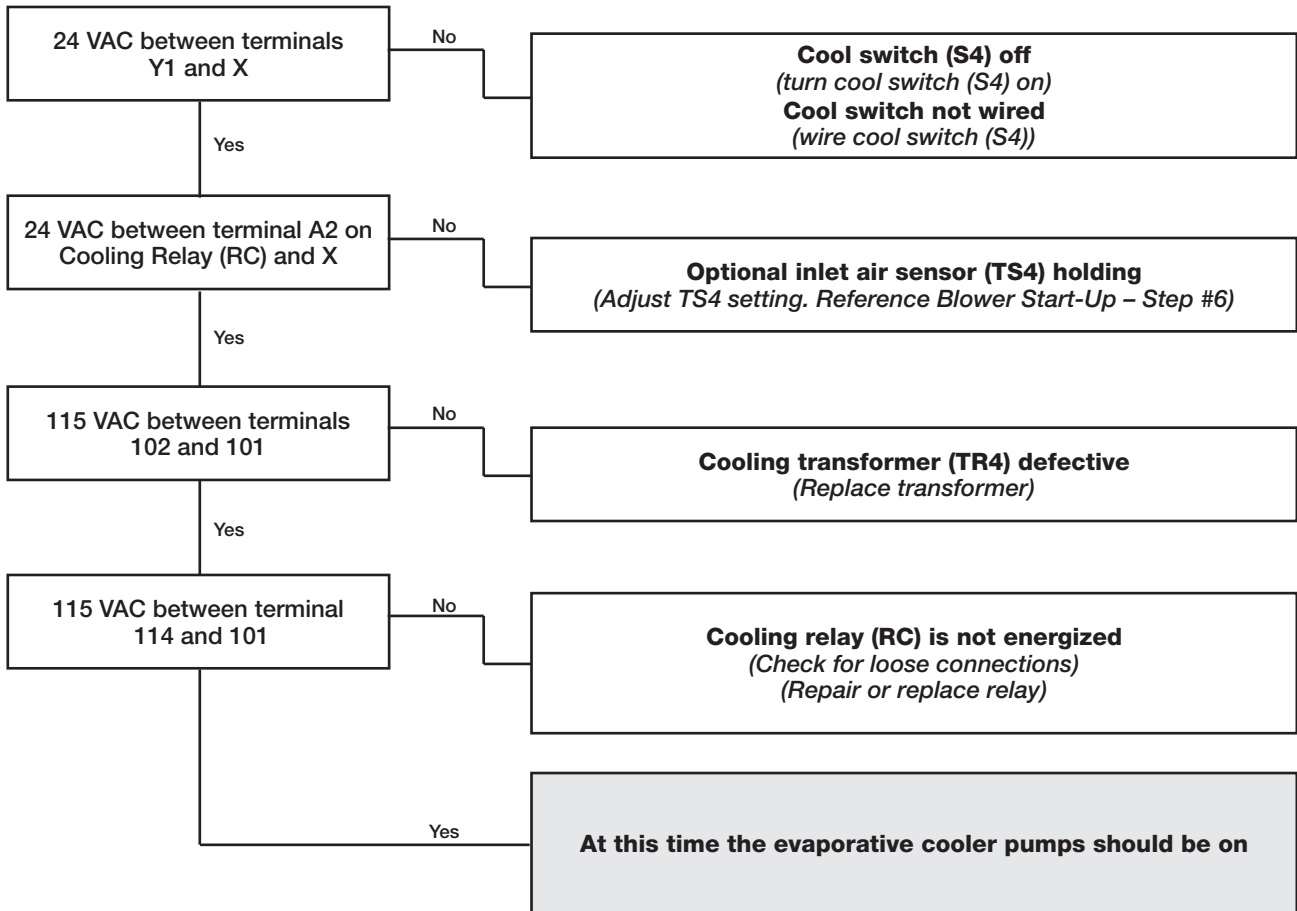

Water Blows through Evaporative Cooler

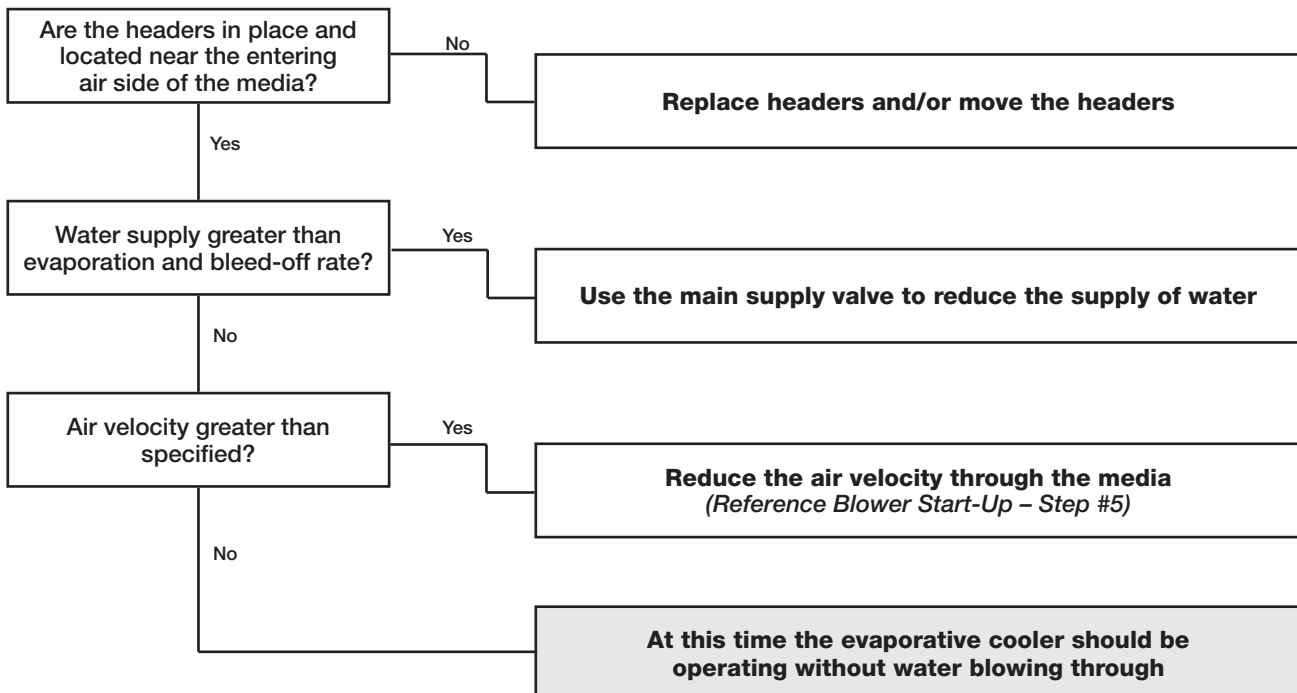

Troubleshooting

Water Wizard™ – Improper Water Supply

NOTE
If the water supply is too low, the media will continuously appear dry.
NOTE
If the water supply is too high, the media will be saturated and excessive water will be draining from the sump tank.
NOTE
Some water drainage is desired to keep the media flushed, but it should be minimized to utilize the Water Wizard™.

1. Adjust the Manual Supply Valve

Adjust the manual supply valve (refer to Start-Up, Water Wizard™). If the recommended water pressure does not provide enough water, increase the pressure until the desired water supply is achieved. If the recommended water pressure provides too much water, decrease the water pressure until the desired water supply is achieved.

CAUTION
Only proceed to Steps 2 and 3 if Step 1 does not correct the problem.

2. Enter Program Mode

 Press and hold the Enter key for three seconds to enter Program Mode. The display will read “Pro” when Program Mode is active.



3. Adjust the On Time Factor

 While in the Program Menu, use the Up and Down keys to navigate through the menu options until “ont” is displayed.



With “ont” displayed, press the Enter key to access the setting.

With the setting displayed, use the Up and Down keys to adjust the setting as needed.

Increase the factor to increase the water supply or decrease the factor to decrease the water supply.

Press the Enter key to save the new On Time Factor and return to the Program Menu.

NOTE
Changing the On Time Factor by (1) will change the water supply by approximately 3%.
IMPORTANT
The Enter key must be pressed to save the new On Time Factor.

4. Exit Program Mode

After 15 seconds of idle time the controller will automatically exit Program Mode.

Maintenance - Routine

CAUTION

Lock-out the gas and the electrical power to the unit before performing any maintenance or service operations to this unit.

V-Belt Drives

V-belt drives must be checked on a regular basis for wear, tension, alignment, and dirt accumulation.

Check the tension by measuring the deflection in the belt as shown below.

Check the alignment by using a straight edge across both sheaves as shown below.

IMPORTANT

Premature or frequent belt failures can be caused by improper belt tension, or misaligned sheaves.

- Abnormally high belt tension or drive misalignment will cause excessive bearing loads and may result in failure of the fan and/or motor bearings.
- Abnormally low belt tension will cause squealing on start-up, excessive belt flutter, slippage, and overheated sheaves.

IMPORTANT

Do not pry belts on or off the sheave. Loosen belt tension until belts can be removed by simply lifting the belts off the sheaves.

IMPORTANT

When replacing V-belts on multiple groove drives, all belts should be changed to provide uniform drive loading.

IMPORTANT

Do not install new belts on worn sheaves. If the sheaves have grooves worn in them, they must be replaced before new belts are installed.

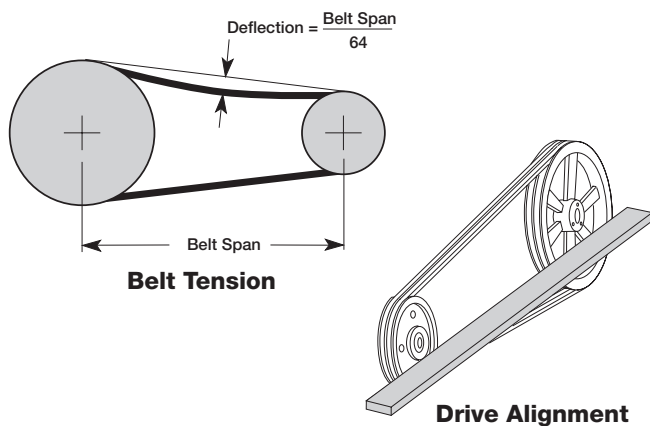

Snow Accumulation

Clear snow away from roof mounted units. Keep the snow clear of the intake and access doors.

Wheels

Wheels require little attention when moving clean air. Occasionally oil and dust may accumulate on the wheel causing imbalance. When this occurs the wheel and housing should be cleaned to assure proper operation.

Bearings

The bearings for our fans are carefully selected to match the maximum load and operating conditions of the specific class, arrangement and fan size. The instructions provided in this manual and those provided by the bearing manufacturer will minimize any bearing problems.

IMPORTANT

Lubricate bearings prior to periods of extended shutdowns or storage and rotate shaft monthly to aid in corrosion prevention. If the fan is stored more than three months, purge the bearings with new grease prior to start-up.

Recommended Bearing Lubrication Schedule (in months*)

Fan RPM	Bearing Bore Size (inches)				
	½-1	1⅛-1½	1⅝-1⅞	1⅞-2⅜	2⅞-3
250	6	6	6	6	6
500	6	6	6	5	4
750	6	5	4	3	3
1000	5	3	2	1	1
1250	5	3	2	1	1
1500	5	2	1	1	0.5
2000	5	1	1	0.5	0.25

*Suggested initial greasing interval is based on 12 hour per day operation and 150°F maximum housing temperature. For continuous (24 hour) operation, decrease greasing interval by 50%

- If extended grease lines are present, relubricate while in operation, only without endangering personnel.
- For ball bearings (operating) relubricate until clean grease is seen purging at the seals. Be sure not to unseat the seal by over lubricating.
- For ball bearings (idle) add 1-2 shots of grease up to 2 inch bore size, and 4-5 shots above 2 inch bore sizes with a hand grease gun.
- For roller bearings add 4 shots of grease up to 2 inch bore size, and 8 shots for 2-5 inch bore size with a hand grease gun.
- Adjust relubrication frequency based on condition of purged grease.
- A high quality lithium based grease conforming to NLGI Grade 2 consistency, such as those listed here:

Mobil 532 Texaco Multifak #2 B Shell Alavanja #2
 Mobilux #2 Texaco Premium #2 Exxon Unirex #2

Motors

Motor maintenance is generally limited to cleaning and lubrication (where applicable).

Cleaning should be limited to exterior surfaces only. Removing dust and grease build-up on the motor assures proper motor cooling.

Motors supplied with grease fittings should be greased in accordance with the manufacturer's recommendations.

IMPORTANT

Do not allow water or solvents to enter the motor or bearings. Motors and bearings should never be sprayed with steam, water or solvents.

IMPORTANT

Greasing motors is only intended when fittings are provided. Many motors are permanently lubricated, requiring no additional lubrication.

Filters

Filter maintenance is generally limited to cleaning and replacement.

If aluminum mesh filters are installed, they can be washed in warm soapy water.

An adhesive spray can be added to aluminum mesh filters to increase their efficiency.

If disposable filters are installed, they can be checked by holding up to a light source. If light cannot pass through the filter, it should be replaced.

IMPORTANT

When reinstalling filters, be sure to install them with the airflow in the correct direction. An airflow direction arrow is located on the side of the filters.

IMPORTANT

Replacement filters should be from the same manufacturer and the same size as the original filters provided with the unit.

Chilled Water Coils

Test the circulating fluid for sediment, corrosive products and biological contaminants. Make the necessary corrective measures.

Maintain adequate fluid velocities and proper filtering of the fluid.

If automatic air vents are not utilized, periodic venting of the coil is recommended to remove accumulated air.

Evaporative Coolers

The media should be periodically brushed lightly with a soft bristle brush in an up and down motion while flushing with water. This aids in reducing the amount of mineral build-up.

For large amounts of mineral build-up, clean or replace the media and increase the water bleed-off or flush rate.

The cooling media has a useful life of 3 to 5 years depending on the water quality and the bleed-off or flush rate.

IMPORTANT

When reinstalling the evaporative media, make sure that it is installed correctly. Reference the drawing shown below.

IMPORTANT

Replacement media should be from the same manufacturer and be the same size as the original media provided with the unit.

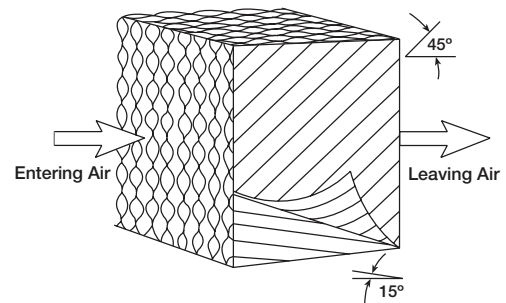

Media Orientation

Cooling Coils

WARNING

Repair and replacement of the coil and the connecting piping, valves, etc., should be performed by a qualified individual.

Inspect the coil for signs of corrosion and/or leaks. Repair any leaks as required.

Inspect the coil's surface for foreign material. If the coil surface needs cleaning, clean the coil from the leaving air-side so that foreign material will be washed out of the coil rather than pushed farther in.

Inspect and clean the drain pan to prevent the growth of algae and other organisms.

IMPORTANT

Be sure to read and follow the manufacturer's recommendations before using any cleaning fluid.

CAUTION

Caution should be used to avoid injury when venting the coil. High pressure and/or high temperature fluids can cause serious injuries.

Maintenance - Fall

High Limit

The high limit switch may have tripped over the summer; it should be checked and reset if necessary.

CAUTION

Lock-out the gas and the electrical power to the unit before performing any maintenance or service operations to this unit.

Gas Line

Remove the drip leg and clean any liquid or debris that may have accumulated. Once the drip leg is cleaned, reattach it.

Gas Train

The gas connections, joints and valves should be checked annually for tightness. Apply a soap and water solution to all piping; watch for bubbling which indicates a leak. Other leak testing methods can be used.

Vent Piping

Remove any debris from the drip legs on the combustion air and exhaust pipes.

Burners and Orifices

Before each heating season, examine the burners and gas orifices to make sure they are clear of any debris such as spider webs, etc. Clean burner as follows:

- Turn off both electrical and gas supplies to the unit.
- Disconnect union between manifold and gas valve.
- Remove manifold and burner assembly.
- Inspect and clean orifices and burners as necessary. Avoid using any hard or sharp instruments which could cause damage to the orifices or burners.
 - Remove any soot deposits from the burner with a wire brush.
 - Clean the ports with an aerosol degreaser or compressed air.
 - Wipe the inside of the burner clean. Cleaning the burner with a degreaser will slow the future build-up of dirt.
- Before reinstalling the burner assembly, look down the heat exchanger tubes to make sure they are clear of any debris.
- Reinstall manifold and burner assembly, reconnect wire leads and gas supply piping.
- Turn on the electrical power and gas supply.
- Follow the start-up procedure to light the burners and verify proper operation.

Heat Exchanger

The heat exchanger should be checked annually for cracks. If a crack is detected, the heat exchanger should be replaced before the unit is put back into operation. Also, airflow across the heat exchanger should be checked to make sure the blower is operating properly.

Flue Collector Box

The flue passageway and flue collector box should be inspected prior to each heating season and cleared of any debris.

Electrical Wiring

The electrical wiring should be checked annually for loose connections or deterioration.

Replacement Parts

When ordering replacement parts, include the complete unit model number and serial number listed on the unit nameplate.

Evaporative Coolers

The water should be shut off and all the lines drained when the outside temperature drops below 45°F.

Remove drain plugs for the winter.

Clean all interior parts of any mineral deposits or foreign materials that may have built-up during the cooling season.

Replace any worn or non-functioning parts.

Winterizing Chilled Water Coils

During the winter, chilled water coils need to be protected against freezing. Manufacturer recommends protecting the coils by either blowing-out the coils or by flushing the coils.

Blowing-Out Coils

1. Close valves on the supply and return lines.
2. Open drain valves and/or drain plug. Remove vent plug to allow coil to drain faster.
3. After coil is fully drained, connect a blower to the caps. Do not connect the blower to the air vent or drain plug.
4. Close the vent plug on the header that the blower is connected to. Open the drain valve or cap on the other header.
5. Turn on blower for 30 minutes. Place mirror at discharge. If the mirror fogs up, repeat procedure until no fog appears on the mirror.
6. After drying the coil, wait a few minutes then repeat Step #5.
7. Leave drains open and do not install plugs until beginning of cooling season.

Flushing Coils

Manufacturer recommends the use of inhibited glycol (such as propylene or ethylene) to flush water coils to protect against freezing. Additionally, the use of inhibited glycol provides corrosion protection.

The table below indicates the percentage of glycol required to prevent freezing in a coil at a given outdoor air freeze point. Completely fill coil with solution. Drain coil. Residual glycol fluid per these concentrations can be left in the coil without concern of freezing. Recovered fluid can be used to flush other coils.

Percent of Ethylene Glycol by Volume	Freeze Point		Percent of Propylene Glycol by Volume	Freeze Point	
	°F	°C		°F	°C
0	32	0	0	32	0
10	25	-4	10	26	-3
20	16	-9	20	19	-7
30	3	-16	30	8	-13
40	-13	-25	40	-7	-22
50	-34	-37	50	-28	-33
60	-55	-48	60	-60	-51

Reference - Model IG Venting Connection Location

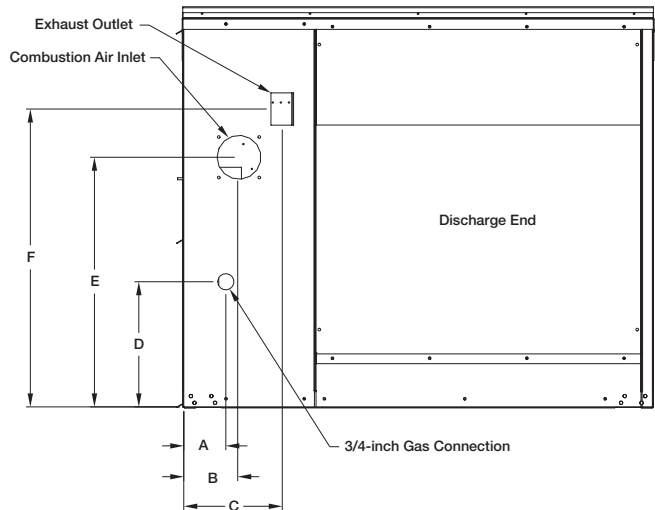

Venting Location Dimensions						
IG Housing	A	B	C	D	E	G
10	3.89	5.12	9.12	11.59	23.11	27.58
20	3.91	3.89	7.89	11.62	25.34	32.27
30	3.91	3.89	7.89	11.62	25.34	32.27

Dimensions are in inches.

Dimensions B and E are not needed for standard venting. A round adapter should be used for the exhaust connection.

Flue Connection Size (diameter in inches)					
IG Housing	Standard	Non-Concentric		Concentric	
	Exhaust	Exhaust	Intake	Exhaust	Intake
10	4.0	4.0	4.0	4.0	6.0
20	6.0	6.0	6.0	6.0	8.0
30	6.0	6.0	6.0	6.0	8.0

Reference - Model IGX Venting Connection Location

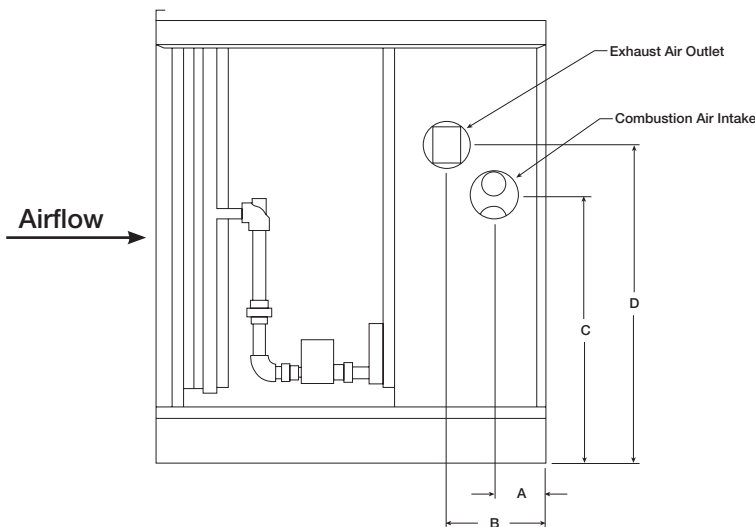

IGX Housing	Furnace Size (MBH)	A	B	C	D	Flue Connection Size (diameter in inches)					
						Standard		Non-Concentric		Concentric	
						Exhaust	Exhaust	Exhaust	Intake	Exhaust	Intake
12	100	4.45	8.45	23.43	27.90	4.0	4.0	4.0	4.0	6.0	
	150	4.45	8.45	23.43	27.90	4.0	4.0	4.0	4.0	6.0	
	200	5.64	9.64	23.97	30.90	6.0	6.0	6.0	6.0	8.0	
	250	5.64	9.64	23.97	30.90	6.0	6.0	6.0	6.0	8.0	
22	150	4.45	8.45	29.38	33.85	4.0	4.0	4.0	4.0	6.0	
	200	5.67	9.67	24.97	31.90	6.0	6.0	6.0	6.0	8.0	
	250	5.67	9.67	24.97	31.90	6.0	6.0	6.0	6.0	8.0	
	300	5.67	9.67	24.97	31.90	6.0	6.0	6.0	6.0	8.0	
	350	5.67	9.67	19.01	25.94	6.0	6.0	6.0	6.0	8.0	
	400	5.67	9.67	19.01	25.94	6.0	6.0	6.0	6.0	8.0	
	500	5.67	9.67	24.97	31.90	6.0	6.0	6.0	6.0	8.0	
	600	5.67	9.67	24.97	31.90	6.0	6.0	6.0	6.0	8.0	
32	350	5.96	9.71	28.31	35.24	6.0	6.0	6.0	6.0	8.0	
	400	5.96	9.71	28.31	35.24	6.0	6.0	6.0	6.0	8.0	
	500	5.96	9.71	28.31	35.24	6.0	6.0	6.0	6.0	8.0	
	600	5.96	9.71	28.31	35.24	6.0	6.0	6.0	6.0	8.0	
	700	5.96	9.71	28.31	35.24	6.0	6.0	6.0	6.0	8.0	
	800	5.96	9.71	28.31	35.24	6.0	6.0	6.0	6.0	8.0	
	1050	5.96	9.71	28.31	35.24	6.0	6.0	6.0	6.0	8.0	
	1200	5.96	9.71	28.31	35.24	6.0	6.0	6.0	6.0	8.0	

Dimensions are in inches. Dimensions A and C are not needed for standard venting.

Reference - Model IG (Single or 2 Stage)

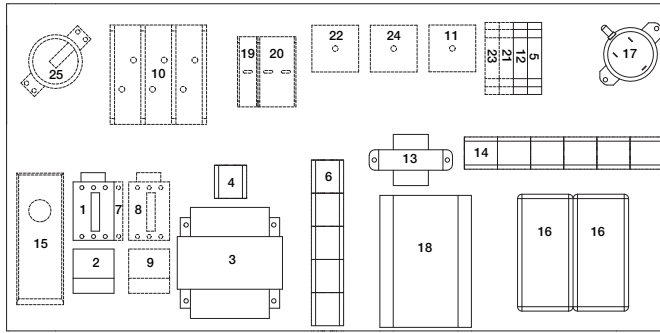

NOTE

This is a typical blower control center, the control center in your unit may be different. Reference the ladder diagram on the inside of the control center door for a unit specific wiring diagram.

1. **Supply Motor Starter** - 24 volt magnetic contacts for starting supply motor.
2. **Supply Overload** - Provides electronic overload protection to supply motor.
3. **Low Voltage Transformer** - Provides low voltage to fan/heat/cooling enable controls, staged furnace controls and optional evaporative cooling controls.
4. **Control Terminal Block** - Provides wiring access to controls.
5. **Fan Relay** - Allows power to pass to energize motor starter.
6. **Control Terminal Block** - Provides wiring access to fan/heat/cooling enable controls.
7. **Auxiliary Contact (Optional)** - Provides one normally closed and one normally open contact for other equipment.
8. **Exhaust Motor Starter (Optional)** - 24 volt magnetic contacts for starting exhaust motor.
9. **Exhaust Overload (Optional)** - Provides electronic overload protection to exhaust motor.
10. **Exhaust Fuses (Optional)** - Provides proper fusing for exhaust fan motor(s).
11. **Building Freeze Protection Timer (Optional)** - Prevents the discharge of cold air into the building.
12. **Heat Relay** - Allows power to pass to heating controls.
13. **Low Voltage Transformer** - Provides low voltage to the ignition controller.
14. **Heating Terminal Block** - Provides wiring access to heating controls.
15. **Inlet Air Sensor (Optional)** - Outdoor air stat that automatically controls the heating and/or cooling based on outdoor air temperature.

16. **Stage Controller** - Provides single or two stage control of the furnace.
17. **Airflow Switch** - Monitors the airflow inside the heat exchanger.
18. **Ignition Controller** - Controls the ignition of the furnace. Maintains safe operation of the furnace.
19. **Evaporative Cooling Fuses (Optional)** - Provides proper fusing to evaporative cooling pump and controls.
20. **Transformer Fuse (Optional)** - Provides proper fusing for evaporative cooling transformer.
21. **Cooling Relay (Optional)** - Allows power to pass to cooling controls.
22. **Reset Timer (Optional)** - Resets cooling system to run a time interval.
23. **Auto Drain Relay (Optional)** - Assures supply pump does not operate during drain interval. Allows pump to operate in cooling mode.
24. **Cooling Timer (Optional)** - Allows for automatic draining of the evaporative cooling system based on time schedule.
25. **Dirty Filter Switch (Optional)** - Monitors filter pressure drop. Turns on indicating light when pressure drop is above field adjustable set point.

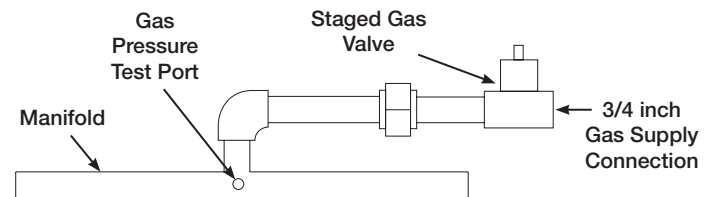

Reference - Model IG (8:1 Staged)

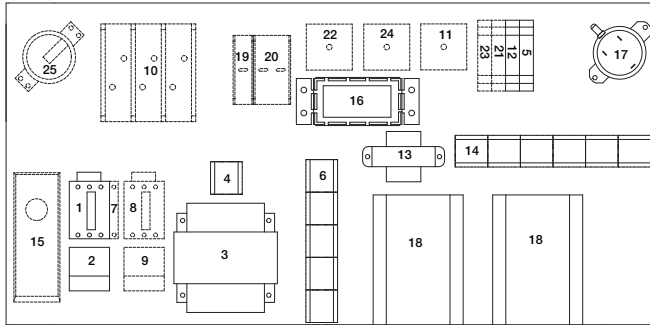

NOTE

This is a typical blower control center, the control center in your unit may be different. Reference the ladder diagram on the inside of the control center door for a unit specific wiring diagram.

1. **Supply Motor Starter** - 24 volt magnetic contacts for starting supply motor.
2. **Supply Overload** - Provides electronic overload protection to supply motor.
3. **Low Voltage Transformer** - Provides low voltage to fan/heat/cooling enable controls, staged furnace controls and optional evaporative cooling controls.
4. **Control Terminal Block** - Provides wiring access to controls.
5. **Fan Relay** - Allows power to pass to energize motor starter.
6. **Control Terminal Block** - Provides wiring access to fan/heat/cooling enable controls.
7. **Auxiliary Contact (Optional)** - Provides one normally closed and one normally open contact for other equipment.
8. **Exhaust Motor Starter (Optional)** - 24 volt magnetic contacts for starting exhaust motor.
9. **Exhaust Overload (Optional)** - Provides electronic overload protection to exhaust motor.
10. **Exhaust Fuses (Optional)** - Provides proper fusing for exhaust fan motor(s).
11. **Building Freeze Protection Timer (Optional)** - Prevents the discharge of cold air into the building.
12. **Heat Relay** - Allows power to pass to heating controls.
13. **Low Voltage Transformer** - Provides low voltage to the ignition controller.
14. **Heating Terminal Block** - Provides wiring access to heating controls.
15. **Inlet Air Sensor (Optional)** - Outdoor air stat that automatically controls the heating and/or cooling based on outdoor air temperature.

16. **Stage Controller** - Provides 8 stage control of the furnace.
17. **Airflow Switch** - Monitors the airflow inside the heat exchanger.
18. **Ignition Controller** - Controls the ignition of the furnace. Maintains safe operation of the furnace.
19. **Evaporative Cooling Fuses (Optional)** - Provides proper fusing to evaporative cooling pump and controls.
20. **Transformer Fuse (Optional)** - Provides proper fusing for evaporative cooling transformer.
21. **Cooling Relay (Optional)** - Allows power to pass to cooling controls.
22. **Reset Timer (Optional)** - Resets cooling system to run a time interval.
23. **Auto Drain Relay (Optional)** - Assures supply pump does not operate during drain interval. Allows pump to operate in cooling mode.
24. **Cooling Timer (Optional)** - Allows for automatic draining of the evaporative cooling system based on time schedule.
25. **Dirty Filter Switch (Optional)** - Monitors filter pressure drop. Turns on indicating light when pressure drop is above field adjustable set point.

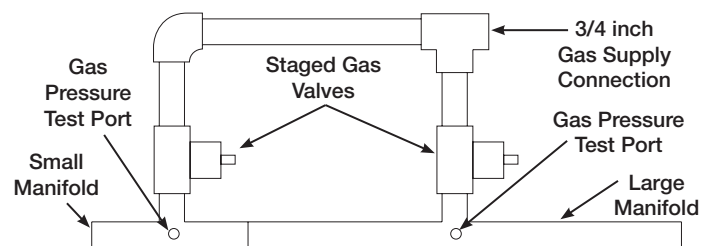

Reference - Model IG (2:1 Modulation)

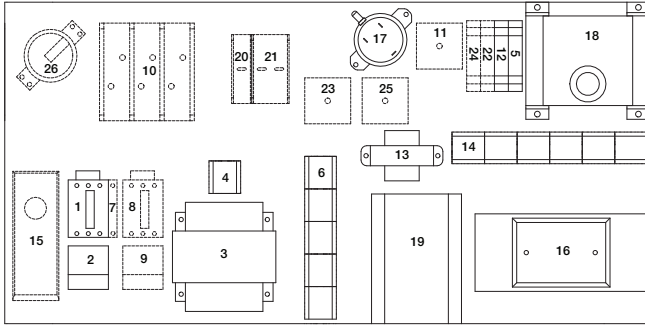

NOTE

This is a typical blower control center, the control center in your unit may be different. Reference the ladder diagram on the inside of the control center door for a unit specific wiring diagram.

1. **Supply Motor Starter** - 24 volt magnetic contacts for starting supply motor.
2. **Supply Overload** - Provides electronic overload protection to supply motor.
3. **Low Voltage Transformer** - Provides low voltage to fan/heat/cooling enable controls, modulating furnace controls and optional evaporative cooling controls.
4. **Control Terminal Block** - Provides wiring access to controls.
5. **Fan Relay** - Allows power to pass to energize motor starter.
6. **Control Terminal Block** - Provides wiring access to fan/heat/cooling enable controls.
7. **Auxiliary Contact (Optional)** - Provides one normally closed and one normally open contact for other equipment.
8. **Exhaust Motor Starter (Optional)** - 24 volt magnetic contacts for starting exhaust motor.
9. **Exhaust Overload (Optional)** - Provides electronic overload protection to exhaust motor.
10. **Exhaust Fuses (Optional)** - Provides proper fusing for exhaust fan motor(s).
11. **Building Freeze Protection Timer (Optional)** - Prevents the discharge of cold air into the building.
12. **Heat Relay** - Allows power to pass to heating controls.
13. **Low Voltage Transformer** - Provides low voltage to the ignition controller.
14. **Heating Terminal Block** - Provides wiring access to heating controls.
15. **Inlet Air Sensor (Optional)** - Outdoor air stat that automatically controls the heating and/or cooling based on outdoor air temperature.

16. **Amplifier** - Controls the modulating valve based on the input from the temperature selector and the discharge air sensor.
17. **Airflow Switch** - Monitors the airflow inside the heat exchanger.
18. **Temperature Selector** - Allows the user to adjust discharge air temperature.
19. **Ignition Controller** - Controls the ignition of the furnace. Maintains safe operation of the furnace.
20. **Evaporative Cooling Fuses (Optional)** - Provides proper fusing to evaporative cooling pump and controls.
21. **Transformer Fuse (Optional)** - Provides proper fusing for evaporative cooling transformer.
22. **Cooling Relay (Optional)** - Allows power to pass to cooling controls.
23. **Reset Timer (Optional)** - Resets cooling system to run a time interval.
24. **Auto Drain Relay (Optional)** - Assures supply pump does not operate during drain interval. Allows pump to operate in cooling mode.
25. **Cooling Timer (Optional)** - Allows for automatic draining of the evaporative cooling system based on time schedule.
26. **Dirty Filter Switch (Optional)** - Monitors filter pressure drop. Turns on indicating light when pressure drop is above field adjustable set point.

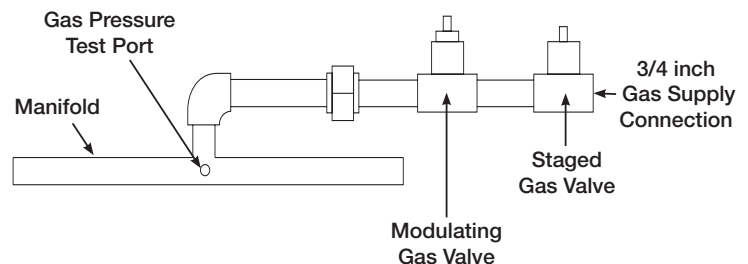

Reference - Model IG (4:1 Modulation)

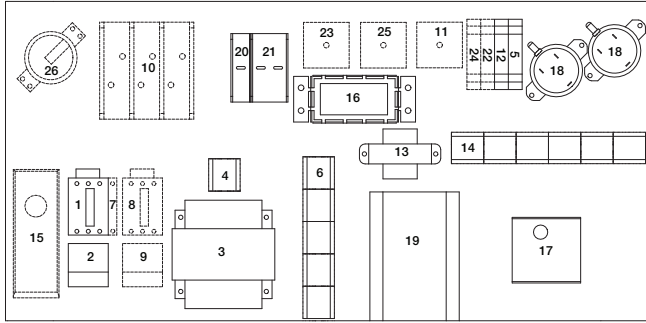

NOTE

This is a typical blower control center, the control center in your unit may be different. Reference the ladder diagram on the inside of the control center door for a unit specific wiring diagram.

1. **Supply Motor Starter** - 24 volt magnetic contacts for starting supply motor.
2. **Supply Overload** - Provides electronic overload protection to supply motor.
3. **Low Voltage Transformer** - Provides low voltage to fan/heat/cooling enable controls, modulating furnace controls and optional evaporative cooling controls.
4. **Control Terminal Block** - Provides wiring access to controls.
5. **Fan Relay** - Allows power to pass to energize motor starter.
6. **Control Terminal Block** - Provides wiring access to fan/heat/cooling enable controls.
7. **Auxiliary Contact (Optional)** - Provides one normally closed and one normally open contact for other equipment.
8. **Exhaust Motor Starter (Optional)** - 24 volt magnetic contacts for starting exhaust motor.
9. **Exhaust Overload (Optional)** - Provides electronic overload protection to exhaust motor.
10. **Exhaust Fuses (Optional)** - Provides proper fusing for exhaust fan motor(s).
11. **Building Freeze Protection Timer (Optional)** - Prevents the discharge of cold air into the building.
12. **Heat Relay** - Allows power to pass to heating controls.
13. **Low Voltage Transformer** - Provides low voltage to the ignition controller.
14. **Heating Terminal Block** - Provides wiring access to heating controls.
15. **Inlet Air Sensor (Optional)** - Outdoor air stat that automatically controls the heating and/or cooling based on outdoor air temperature.

16. **Modulation Controller** - Provides 4:1 modulating turndown control of the furnace.
17. **Amplifier** - Controls the modulating valve based on the input from the modulation controller settings and the discharge air sensor.
18. **Airflow Switch** - Monitors the airflow inside the heat exchanger.
19. **Ignition Controller** - Controls the ignition of the furnace. Maintains safe operation of the furnace.
20. **Modulation Controller (Optional)** - Provides proper fusing to modulation controller.
21. **Transformer Fuse (Optional)** - Provides proper fusing to low voltage transformer.
22. **Cooling Relay (Optional)** - Allows power to pass to cooling controls.
23. **Reset Timer (Optional)** - Resets cooling system to run a time interval.
24. **Auto Drain Relay (Optional)** - Assures supply pump does not operate during drain interval. Allows pump to operate in cooling mode.
25. **Cooling Timer (Optional)** - Allows for automatic draining of the evaporative cooling system based on time schedule.
26. **Dirty Filter Switch (Optional)** - Monitors filter pressure drop. Turns on indicating light when pressure drop is above field adjustable set point.

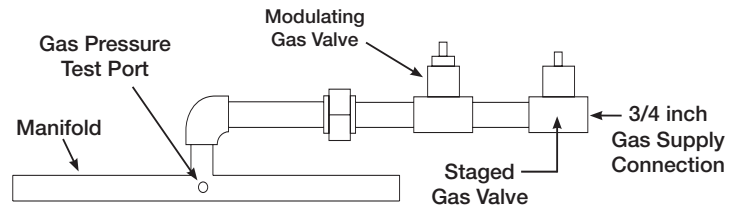

Reference - Model IGX (Blower Control Center)

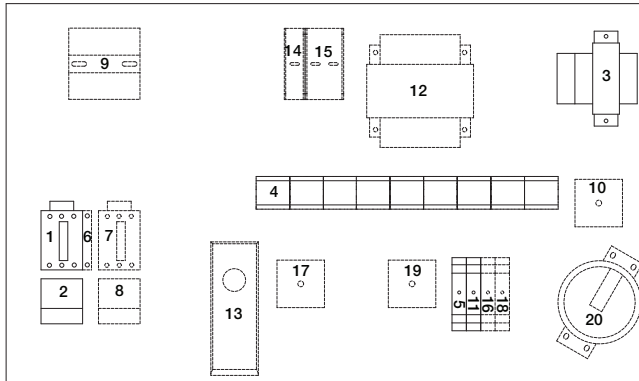

NOTE

This is a typical blower control center, the control center in your unit may be different. Reference the ladder diagram on the inside of the control center door for a unit specific wiring diagram.

1. **Supply Motor Starter** - 24 volt magnetic contacts for starting supply motor.
2. **Supply Overload** - Provides electronic overload protection to supply motor.
3. **Low Voltage Transformer** - Provides low voltage to fan/heat/cooling enable controls.
4. **Control Terminal Block** - Provides wiring access to controls.
5. **Fan Relay** - Allows power to pass to energize motor starter.
6. **Auxiliary Contact (Optional)** - Provides one normally closed and one normally open contact for other equipment.
7. **Exhaust Motor Starter (Optional)** - 24 volt magnetic contacts for starting exhaust motor.
8. **Exhaust Overload (Optional)** - Provides electronic overload protection to exhaust motor.
9. **Exhaust Fuses (Optional)** - Provides proper fusing for exhaust fan motor(s).
10. **Building Freeze Protection Timer (Optional)** - Prevents the discharge of cold air into the building.
11. **Heat Relay** - Allows power to pass to heating controls.
12. **Low Voltage Transformer** - Provides low voltage to the optional evaporative cooling controls.
13. **Inlet Air Sensor (Optional)** - Outdoor air stat that automatically controls the heating and/or cooling based on outdoor air temperature.
14. **Evaporative Cooling Fuses (Optional)** - Provides proper fusing to evaporative cooling pump and controls.
15. **Transformer Fuse (Optional)** - Provides proper fusing for evaporative cooling transformer.

16. **Cooling Relay (Optional)** - Allows power to pass to cooling controls.
17. **Reset Timer (Optional)** - Resets cooling system to run a time interval.
18. **Auto Drain Relay (Optional)** - Assures supply pump does not operate during drain interval. Allows pump to operate in cooling mode.
19. **Cooling Timer (Optional)** - Allows for automatic draining of the evaporative cooling system based on time schedule.
20. **Dirty Filter Switch (Optional)** - Monitors filter pressure drop. Turns on indicating light when pressure drop is above field adjustable set point.

Reference - Model IGX (Single or 2 Stage)

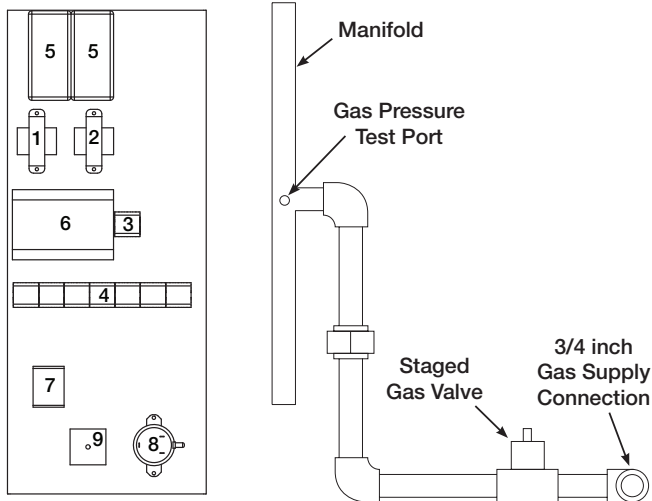

NOTE

This is a typical furnace control center, the control center in your unit may be different. Reference the ladder diagram on the inside of the control center door for a unit specific wiring diagram.

1. **Low Voltage Transformer** - Provides low voltage to the ignition controller.
2. **Low Voltage Transformer** - Provides low voltage to the ignition stage controller.
3. **Control Terminal Block** - Provides wiring access to heat controls.
4. **Control Terminal Block** - Provides wiring access to heat/combustion blower controls.
5. **Stage Controller** - Provides single or two stages of furnace control based on discharge air temperature set point.
6. **Ignition Controller** - Controls the ignition of the furnace. Maintains safe operation of the furnace.
7. **Combustion Blower Contact** - Passes power to the combustion blower.
8. **Airflow Switch** - Monitors the airflow inside the heat exchanger to ensure proper combustion airflow.
9. **High Fire Relay** - Allows furnace to ignite on high fire.

Reference - Model IGX (8:1 Staged)

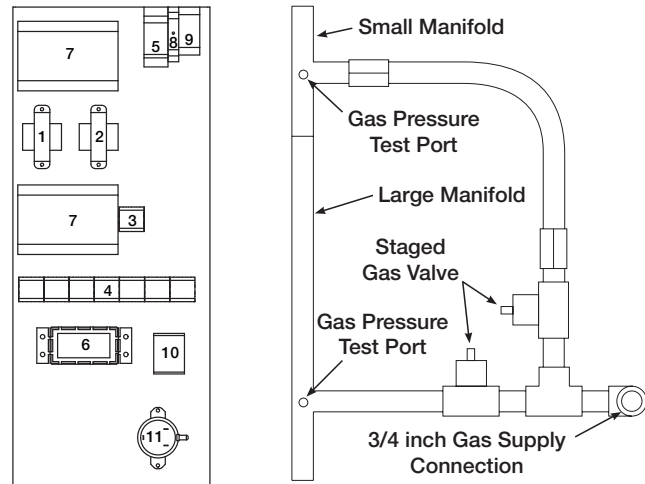

NOTE

This is a typical furnace control center, the control center in your unit may be different. Reference the ladder diagram on the inside of the control center door for a unit specific wiring diagram.

1. **Low Voltage Transformer** - Provides low voltage to the staged controller.
2. **Low Voltage Transformer** - Provides low voltage to the ignition controllers.
3. **Control Terminal Block** - Provides wiring access to controls.
4. **Control Terminal Block** - Provides wiring access to controls.
5. **Input Converter** - Receives and converts signal from Building Management Systems (BMS).
6. **Stage Controller** - Provides eight stages of control based on discharge temperature set point.
7. **Ignition Controllers** - Controls the ignition of the furnace. Maintains safe operation of the furnace.
8. **Contact Relay** - Allows power to pass to the combustion blower contact.
9. **Air Proving Switch Relay** - Functions as a relay for the pressure switch.
10. **Combustion Blower Contact** - Passes power to the combustion blower.
11. **Airflow Switch** - Monitors the airflow inside the heat exchanger.

Reference - Model IGX (2:1 Modulation)

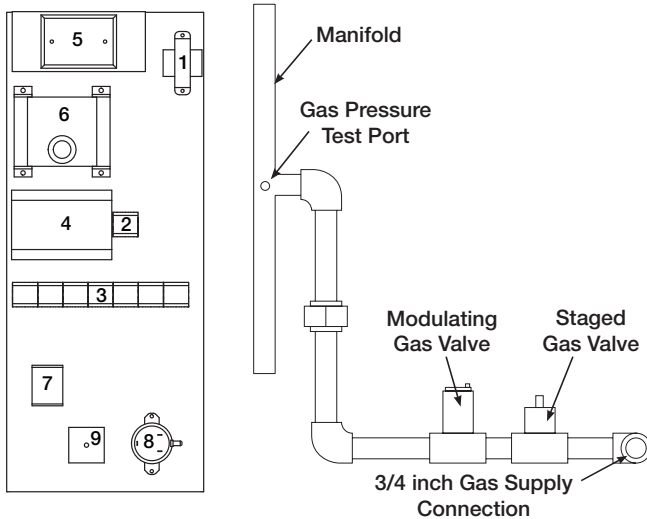

NOTE

This is a typical furnace control center, the control center in your unit may be different. Reference the ladder diagram on the inside of the control center door for a unit specific wiring diagram.

1. **Low Voltage Transformer** - Provides low voltage to the ignition controller and amplifier.
2. **Control Terminal Block** - Provides wiring access to heat controls.
3. **Control Terminal Block** - Provides wiring access to heat controls.
4. **Ignition Controller** - Controls the ignition of the furnace. Maintains safe operation of the furnace.
5. **Amplifier** - Controls the modulating valve based on the input from the temperature selector and the discharge air sensor.
6. **Temperature Selector** - Allows the user to adjust discharge air temperature.
7. **Combustion Blower Contact** - Passes power to the combustion blower.
8. **Airflow Switch** - Monitors the airflow inside the heat exchanger to ensure proper combustion airflow.
9. **High Fire Relay** - Allows furnace to ignite on high fire.

Reference - Model IGX (4:1 Modulation)

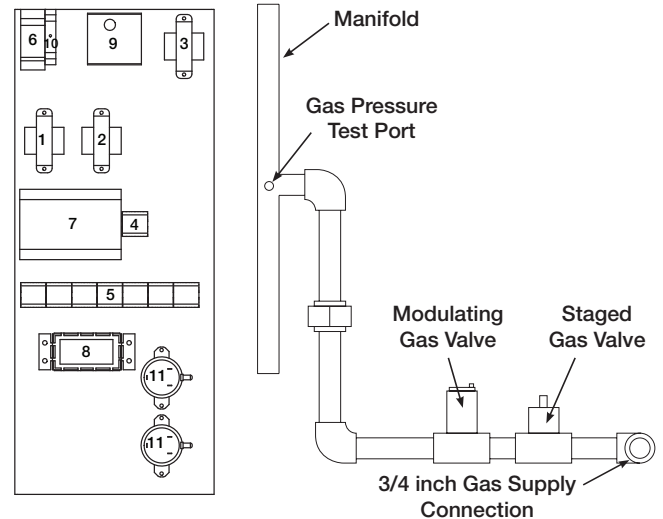

NOTE

This is a typical furnace control center, the control center in your unit may be different. Reference the ladder diagram on the inside of the control center door for a unit specific wiring diagram.

1. **Low Voltage Transformer** - Provides low voltage to the ignition controller.
2. **Low Voltage Transformer** - Provides low voltage to the 4:1 electronic modulation controller.
3. **Low Voltage Transformer** - Provides low voltage to the amplifier.
4. **Control Terminal Block** - Provides wiring access to controls.
5. **Control Terminal Block** - Provides wiring access to controls.
6. **Input Converter** - Receives and converts signal from Building Management System (BMS).
7. **Ignition Controllers** - Controls the ignition of the furnace. Maintains safe operation of the furnace.
8. **Modulation Controller** - Provides 4:1 modulation turndown control of furnace based on the discharge air temperature.
9. **Amplifier** - Controls the modulating valve based on the input from the modulation controller settings and discharge air temperature sensor reading.
10. **Combustion Blower Relay** - Passes power to the variable speed combustion blower.
11. **Airflow Switches** - Monitors the airflow inside the heat exchanger to ensure proper combustion airflow.

Reference - Performance Table

Performance Table

The following table gives the air volume in cubic feet per minute that is required to provide the desired temperature rise for a given heating input. Model IG has a maximum 7,000 CFM capacity.

Input (MBH)	Output (MBH)	Temperature Rise (°F)															
		25	30	35	40	45	50	55	60	65	70	75	80	85	90	95	100
100	80	2963	2469	2116	1852	1646	1481	1347	1235	1140	1058	988	926	871	823	780	741
150	120	4444	3704	3175	2778	2469	2222	2020	1852	1709	1587	1481	1389	1307	1235	1170	1111
200	160	5926	4938	4233	3704	3292	2963	2694	2469	2279	2116	1975	1852	1743	1646	1559	1481
250	200	7407	6173	5291	4630	4115	3704	3367	3086	2849	2646	2469	2315	2179	2058	1949	1852
300	240	8889	7407	6349	5556	4938	4444	4040	3704	3419	3175	2963	2778	2614	2469	2339	2222
350	280	10370	8642	7407	6481	5761	5185	4714	4321	3989	3704	3457	3241	3050	2881	2729	2593
400	320	11852	9877	8466	7407	6584	5926	5387	4938	4558	4233	3951	3704	3486	3292	3119	2963
500	400	14815	12346	10582	9259	8230	7407	6734	6173	5698	5291	4938	4630	4357	4115	3899	3704
600	480	NA	14815	12698	11111	9877	8889	8081	7407	6838	6349	5926	5556	5229	4938	4678	4444
700	560	NA	NA	14815	12963	11523	10370	9428	8642	7977	7407	6914	6481	6100	5761	5458	5185
800	640	NA	NA	NA	14815	13169	11852	10774	9877	9117	8466	7901	7407	6972	6584	6238	5926
1050	840	NA	NA	NA	NA	NA	NA	14141	12963	11966	11111	10370	9722	9150	8642	8187	7778
1200	960	NA	NA	NA	NA	NA	NA	NA	14815	13675	12698	11852	11111	10458	9877	9357	8889

Reference - Start-Up Checklist

Start-Up Checklist

Unit Model Number _____ (e.g. IGX-120-H32-DB)
 Unit Serial Number _____ (e.g. 10111000)
 Start-Up Date _____
 Start-Up Personnel Name _____
 Start-Up Company _____
 Phone Number _____

Pre Start-Up Checklist - check boxes as items are completed

- Check tightness of all factory wiring connections
- Verify control wiring wire gauge
- Hand-rotate blower to verify free rotation
- Verify supply voltage to the main disconnect
- Verify the supply gas pressure
- Verify remote controls wiring

Start-Up Blower Checklist - refer to Blower Start-Up section for further detail

- Check line voltage L1-L2 _____ L2-L3 _____ L1-L3 _____
- Check blower rotation
- Check for vibration
- Supply fan RPM _____ RPM
- Motor nameplate amps _____ Amps
- Actual motor amps _____ Amps
- Actual CFM delivered _____ CFM

Optional Accessories - refer to Blower Start-Up section, Step #6 for further detail

- Heating inlet air sensor _____ Actual Setting (Typical Setting 60-70°F)
- Cooling inlet air sensor _____ Actual Setting (Typical Setting 75°F)
- Building freeze protection _____ Actual Setting (Typical Setting 5 min; 45°F)
- Dirty filter gauge _____ Actual Setting (Typical Setting varies)

Start-Up Indirect Gas - refer to Furnace Start-Up section for further detail

Furnace 1

- Determine furnace control type _____ 1 Stage - 2 Stage - 8 Stage - 2:1 Mod. - 4:1 Mod.
- Check supply gas pressure _____ Maximum _____ Minimum _____ Actual
- Set the High Manifold pressure _____ in. wg
- Set the Low Manifold pressure _____ in. wg
- Set the unit's operating temperature _____ degrees F

Furnace 2 (Optional)

- Determine furnace control type _____ 1 Stage - 2 Stage - 8 Stage - 2:1 Mod. - 4:1 Mod.
- Check supply gas pressure _____ Maximum _____ Minimum _____ Actual
- Set the High Manifold pressure _____ in. wg
- Set the Low Manifold pressure _____ in. wg

Furnace 3 (Optional)

- Determine furnace control type _____ 1 Stage - 2 Stage - 8 Stage - 2:1 Mod. - 4:1 Mod.
- Check supply gas pressure _____ Maximum _____ Minimum _____ Actual
- Set the High Manifold pressure _____ in. wg
- Set the Low Manifold pressure _____ in. wg

Maintenance Log

Date _____ Time _____ AM/PM

Notes: _____

Date _____ Time _____ AM/PM

Notes: _____

Date _____ Time _____ AM/PM

Notes: _____

Date _____ Time _____ AM/PM

Notes: _____

Date _____ Time _____ AM/PM

Notes: _____

Date _____ Time _____ AM/PM

Notes: _____

Warranty

Greenheck warrants this equipment to be free from defects in material and workmanship for a period of one year from the shipment date. Any units or parts which prove defective during the warranty period will be replaced at our option when returned to our factory, transportation prepaid. Motors are warranted by the motor manufacturer for a period of one year. Should motors furnished by Greenheck prove defective during this period, they should be returned to the nearest authorized motor service station. Greenheck will not be responsible for any removal or installation costs.

As a result of our commitment to continuous improvement, Greenheck reserves the right to change specifications without notice.

Greenheck Catalogs IG, IGX, IG-HV and IGX-HV provide additional information describing the equipment, fan performance, available accessories, and specification data.

AMCA Publication 410-96, Safety Practices for Users and Installers of Industrial and Commercial Fans, provides additional safety information. This publication can be obtained from AMCA International, Inc. at: www.amca.org.



Phone: (715) 359-6171 • Fax: (715) 355-2399 • E-mail: gfcinfo@greenheck.com • Web site: www.greenheck.com